

1
1
35
63
63
106
175
175
213

6
15 15
15 15
15 15

1. 1-1
1
1

001	1979/4/12
002	1981/5/18
003	1978/4/14
004	1980/7/25
005	1981/6/27
006	1981/1/18
007	

014						1983/10/25	
-----	--	--	--	--	--	------------	--

2

Excel

14

Excel

Word

2

	2	30	
	1	30 40	Office
	5		
	30		
	30	2	

3

60

4

(20)	5		5	
	5		1	4
	10		5	5
(80)	10		1 1	0
	20		1 5 5	

		30		1 5 1 5 5	
		20		1 5 5	

2

1-2

1

1

	30	
	30 2	

3

60

4

5

Ê

(20)

3.

1-3

1

1



x x

159*****135



x x

KH010101 135*****129



x x

182*****174



x x

KH010102 151*****525

2

Excel

Excel

2

	2	30
	1	30 40 Office
5		
	30	
	30	2

3

60

4

(20)	5		5	
	5		1	4
	10			5

				5	0
(80)		30		1 5 1 5	
		20		1 1	
		30		1 5 1 5	

4.

1-4

1

1

2

Excel

Excel

2

	2	30
	1	30 40 Of fi ce
5		
	30	
	30	2

3

60

4

	5		5	

(20)

5

0

1

30 40

Office

5

30

30

2

6.

1-6

1

1

2014 6 10

001

	2	30	
	1	30 40	Office
	5		
	30		
	30	2	

3

60

4

(20)	5		5	0
	5		1	
	10		4	
(80)	20		5	
	30		1 5	
	30		1 5	
	30		5	

7. 1-7

1

1

1

	0730206		6				150
	73		10950		68		

2

	0730201		1				200
	95		19000		48		

3

	0730204		4				180
	74		13320		14		

2

Excel

" " " " " " "

Excel

2

	2	30
	1	30 40 Office
5		
	30	

	30	2	
--	----	---	--

3

60

4

(20)	5		5	0
	5		1 4	
	10		5 5	
(80)	30		1 5 1 5	
	20		1 1	
	30		1 5 1 5	

8.

1-8

1

1

		A	B	C		
20041001		175	285	120		
20041002		99	175	164		
20041003		158	169	275		
20041004		244	190	191		
20041005		184	287	188		
20041006		172	268	285		
20041007		185	271	176		
20041008		288	185	275		
20041009		178	280	176		
20041010		194	287	282		
20041011		260	76	271		

2

Excel

100

200

100

200

300

Excel

Excel

2

	2	30

	1	30	40	Office
	5			
		30		
	30	2		

3

60

4

(20)	5		5	
	5		1	4
	10		5	5
			5	0
(80)	20		1	1
	20		1	5
	20		1	5
	20		1	5

9.

1-9

1

1

2014 1 5

A. 0***3

50

30

5500

2

Excel

Excel

2

	2 30	
	1 30 40 Office	
	5	
	30	
	30 2	

3

60

4

(20)		5		1		0
					4	
(80)		10			5	
				5		
(80)		30		1	5	
				1	5	
		20		1	1	
		30		1	5	
				1	5	

10.

1-10

1

1

2014 9 18

A. 4***8

**

15928***135

15 2014 10 10

H20140918

1	24 /	100	64.50
2	50 /	100	72.50
1	50kg/	150	120.00
2	50kg/	150	140.00
1	24 /	200	90.00
2	50 /	200	110.00

2

Excel

Excel

2

--	--	--

	2	30	
	1	30 40	Office
	5		
	30		
	30	2	

3

60

4

(20)	5		5	0
	5		1	
	10		4	
(80)	30		5	0
	30		1 5 1 5	
	20		1 1	
	30		1 5 1 5	

11.

1-11

1

1

2014 9 15

D20134091006

159*****135

2

Excel

Excel

2

	2	30
	1	30 40 Office
5		
	30	
30	2	

3

60

4

	5		5

(20)		5		1		0
				4		
(80)		10		5		
				5		
		30		1 5 1 5		
(80)		20		1 1		
		30		5		

12

1-12

1

1

	40,000.00	12,500.00	10,000.00	2,000.00	3,000.00	1,200.00	500.00		
	60,000.00	35,000.00	20,000.00	2,000.00	2,800.00	3,000.00	1,000.00		
	30,000.00	14,000.00	8,500.00	1,000.00	2,650.00	1,000.00	800.00		
	70,000.00	35,000.00	10,000.00	1,000.00	2,400.00	1,200.00	500.00		
	60,000.00	34,000.00	9,500.00	1,000.00	3,000.00	1,000.00	600.00		
	20,000.00	10,000.00	7,500.00	2,000.00	2,700.00	1,000.00	1,200.00		
	40,000.00	23,000.00	12,000.00	1,000.00	3,100.00	1,000.00	900.00		
	50,000.00	25,000.00	14,000.00	2,000.00	2,900.00	1,000.00	700.00		

2

Excel

Word

IF

Excel

Excel

Word

2

	2	30
	1	30 40 Office
	5	
	30	
	30	2

3

60

4

(20)	5		5	0
	5		1 4	
	10		5 5	
10		1 1		
(80)	20		1 5 5	
	30		1 5 1 5	
	20		1 5 5	

13.

1-13

1

1

1	2013/6/12	x x	1	10	23.00			
2	2013/6/12	x x	3	12	42.00			
3	2013/6/12	x x	1	4	45.00			
4	2013/6/15	x x	2	24	41.00			
5	2013/6/15	x x	3	25	32.00			
6	2013/6/15	x x	1	40	8.00			
7	2013/6/15	x x	2	20	12.00			
8	2013/6/19	x x	1	5	23.00			
9	2013/6/20	x x	2	10	31.00			
10	2013/6/21	x x	3	18	15.00			

2

Excel

Word

Excel

Excel

Word

2

	2	30
	1	30 40 Office
	5	
	30	
	30	2

3

60

4

(20)	5		5	0
	5		1 4	
	10		5 5	
(80)	10		1 1	
	10		1 5 5	
	20		1 5 1 5	
	20		1 5 1 5	

		20		1 5 5	
--	--	----	--	----------	--

14.

1-14

1

1

YC2012001		399	273
YC2012002	VI P	546	234
YC2012003		700	282
YC2012004		357	288
YC2012005		385	183
YC2012006		644	213
YC2012007	VI P	455	285
YC2012008		385	183
YC2012009		504	400
YC2012010		588	237
YC2012018		665	198
YC2012019		700	282
YC2012020		469	282
YC2012021	VI P	378	210
YC2012022		665	204
Q04	(

Excel

Excel

Word

2

	2	30
	1	30 40 Office
	5	
	30	
	30	2

3

60

4

(20)	5		5	0
	5		1 4	
	10		5 5	
(80)	10		1 1	
	10		1 5 5	
	20		1 5 1 5	

				5	
		20		1 5 1 5 ,	
		20		1 5 5	

15.

1-15

1

1

93,076.4	92,064.7	67,783.9	101,170.0	77,900.9
70,819.0	64,748.8	83,971.1	94,088.1	88,017.9
58,678.6	51,596.7	83,971.1	55,643.5	91,053.0
73,585.1	54,631.8	83,971.1	53,620.1	96,111.5
76,889.2	59,690.3	83,971.1	70,819.0	91,053.0
88,017.9	56,655.2	83,971.1	53,620.1	76,889.2
59,690.3	98,134.9	83,971.1	83,971.1	52,608.4
59,690.3	95,099.8	83,971.1	94,088.1	88,017.9

24' 3380

~~02880140~~

1

Excel

Word

40% 30% 30%

10

100.0%

20.0%

120.0%

/

Excel

10

Excel

Word

2

	2	30
	1	30 40 Office
5		
	30	
30	2	

3

60

4

--	--	--	--	--

(20)		5		5	0
		5		1 4	
		10		5 5	
(80)		10		1 1	
		10		1 5 5	
		20		1 5 1 5	
		20		1 5 1 5	
		20		1 5 5	

1.

2-1

1

1

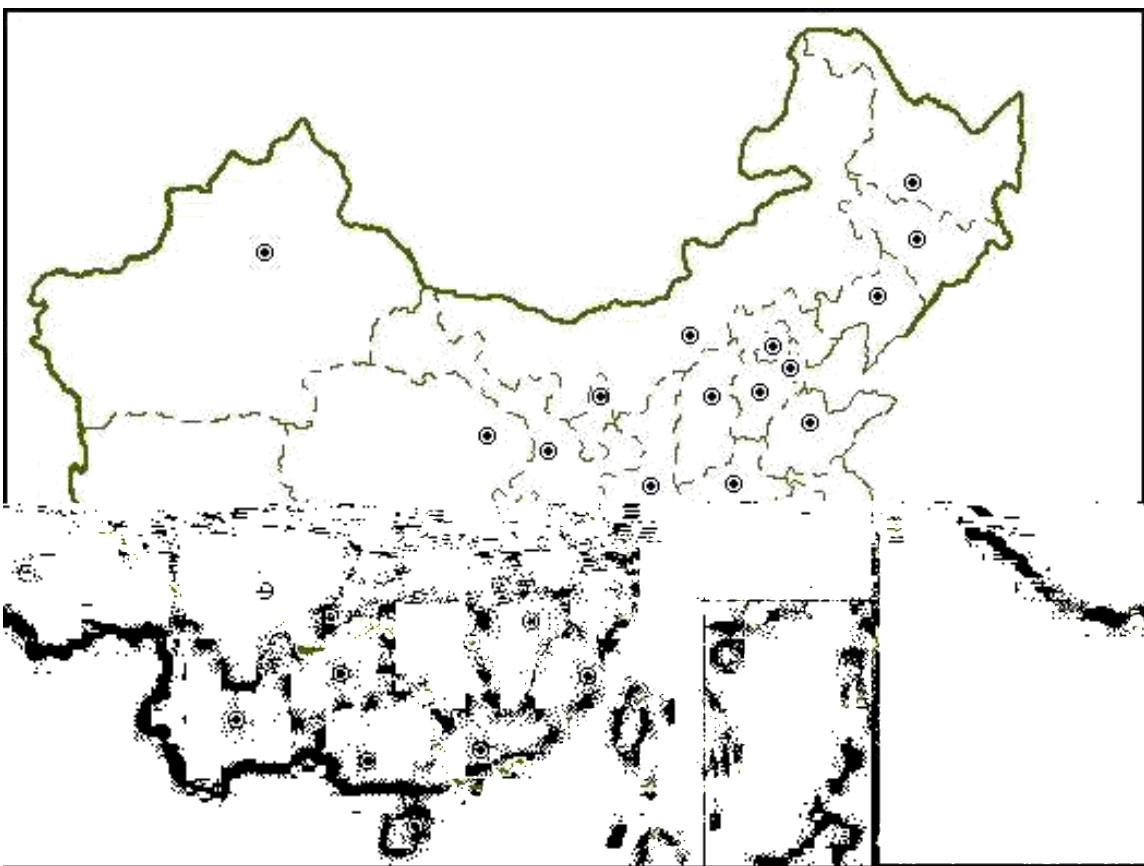

2

" "

Word

2

	2	30
	1	30 40 Office
	5	
	30	
	30	2

3

60

4

(20)	5		5	0
	5		1 4	
	10		5 5	
(80)	30		1 2 1 2	
	30		1 2 1 2	
	20		1 2 1 2	

2

2-2

1

1



2

2-3

400

Word

2

	2	30
	1	30 40 Office
	5	
	30	
	30	2

3

60

4

(20)	5		5	0
	5		1 4	
	10		5 5	
(80)	20		1 2 1 2	
	20		1 2 1 2	
	20	3-5	1 2 3 1 2	
	20		2	

3.

2-3

1

1

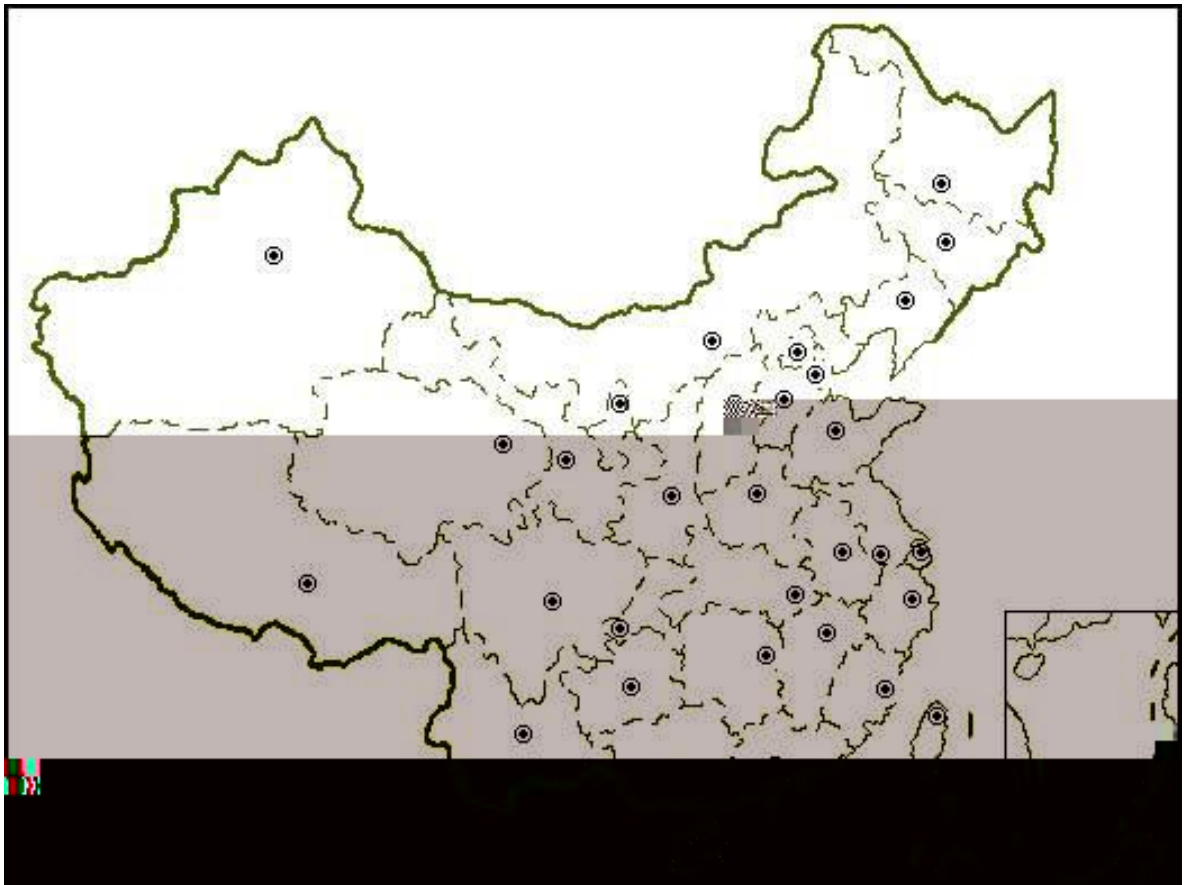

2

" "

" "

3-5

400

Wörd

2

	2	30
	1	30 40 Office
	5	
	30	
	30	2

3

60

4

(20)	5		5	0
	5		1 4	
	10		5 5	
(80)	20		1 2 1 2	
	20		1 2 1 2	
	20	3-5	2 1 2 3	
	20		1 2 10 10	

4.

2-4

1

1

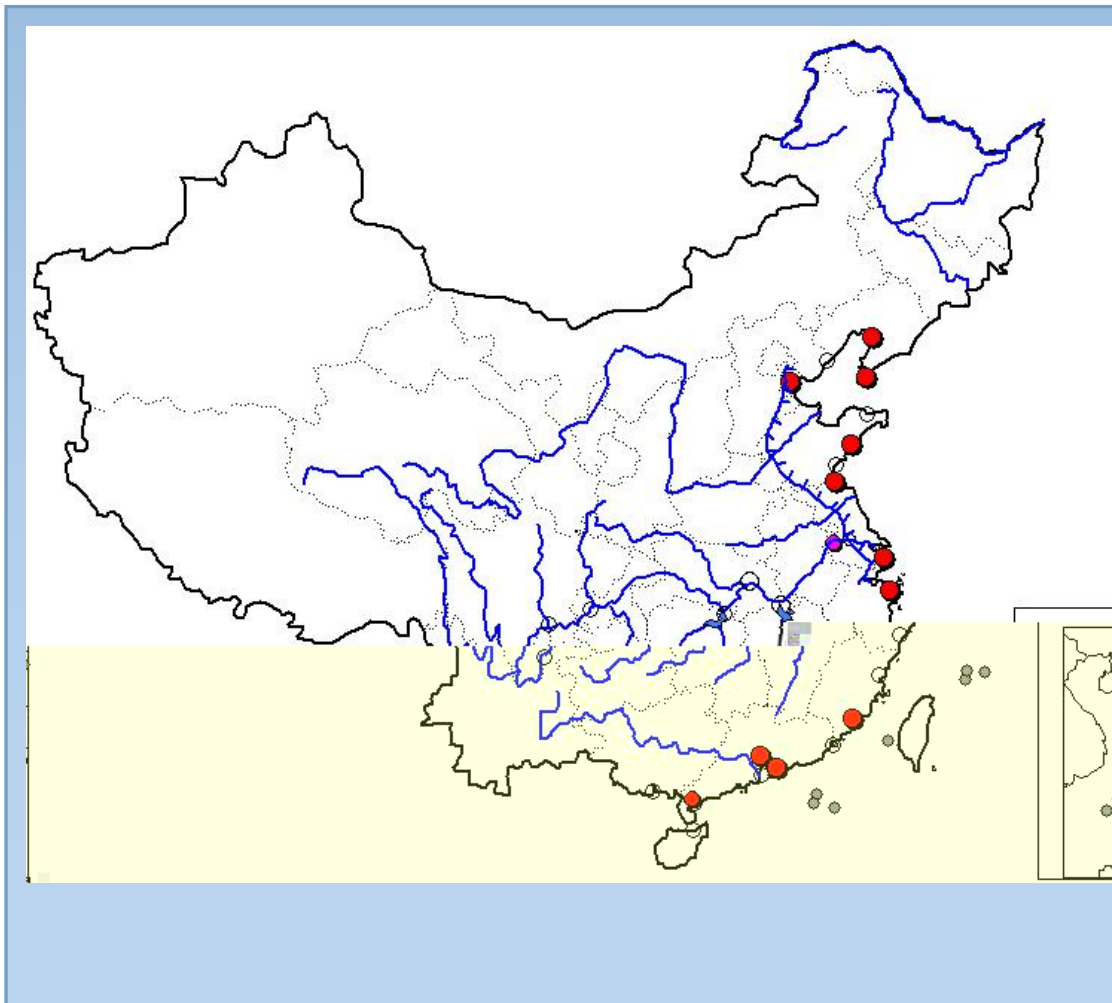

2

Word

2

2

30

1

30 40

Office

5

30

30

2

5.

2-5

1

1

30

3

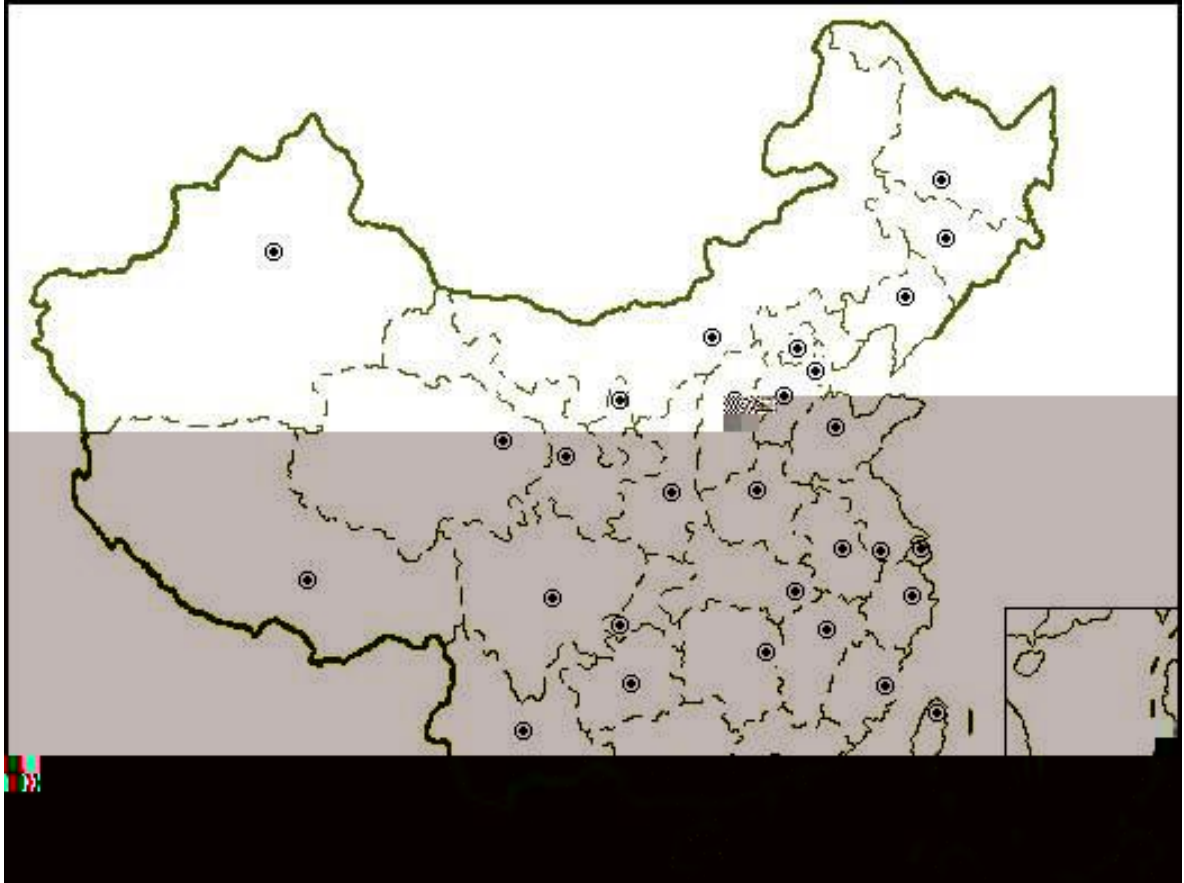

2

3-5

Word

2

	2	30

	1	30	40	Office
	5			
		30		
	30	2		

3

60

4

(20)	5		5	
	5		1	
	10		4	
(80)			5	0
	20		5	5
	10		1	2
	20		1	5
	10	3-5	1	5
			1	5
	20		1	5

6.

2-6

1

1

2000

14

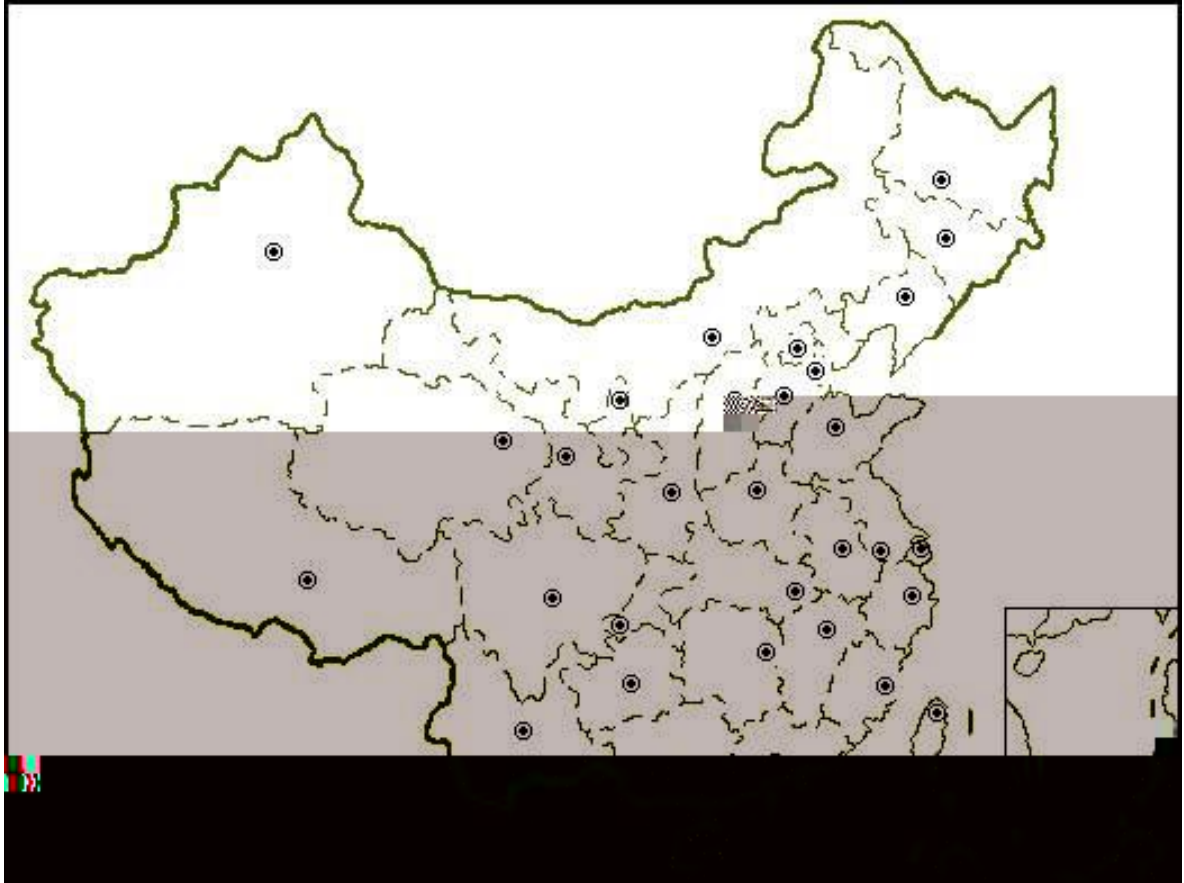

2

3-5

Word

2

	2	30

	1	30	40	Office
	5			
		30		
	30	2		

3

60

4

(20)	5		5	
	5		1	
	10		4	
(80)			5	0
	20		5	
	10		1	2
	20		1	5
	10	3-5	1	5
	20		1	5

7.

2-7

1

1

1000

10

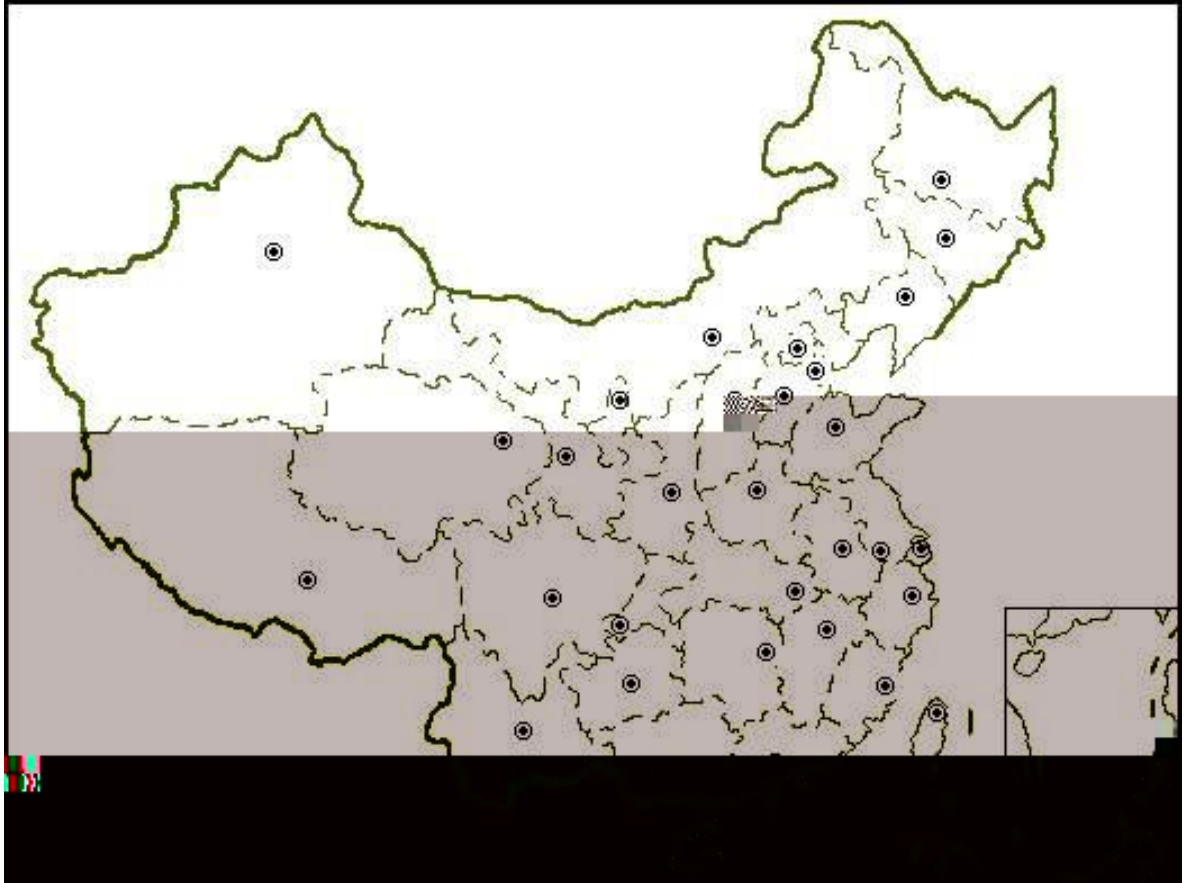

2

3-5

Word

2

	2	30

	1	30	40	Office
	5			
		30		
	30	2		

3

60

4

5

(20)

	1	30	40	Office
	5			
		30		
	30	2		

3

60

4

(20)	5		5	
	5		1	
	10		4	
(80)			5	0
	20		5	5
	10		1	2
	10		1	5
	20	3-5	1	5
			1	5
	20		1	5

9.

2-9

1

1

20

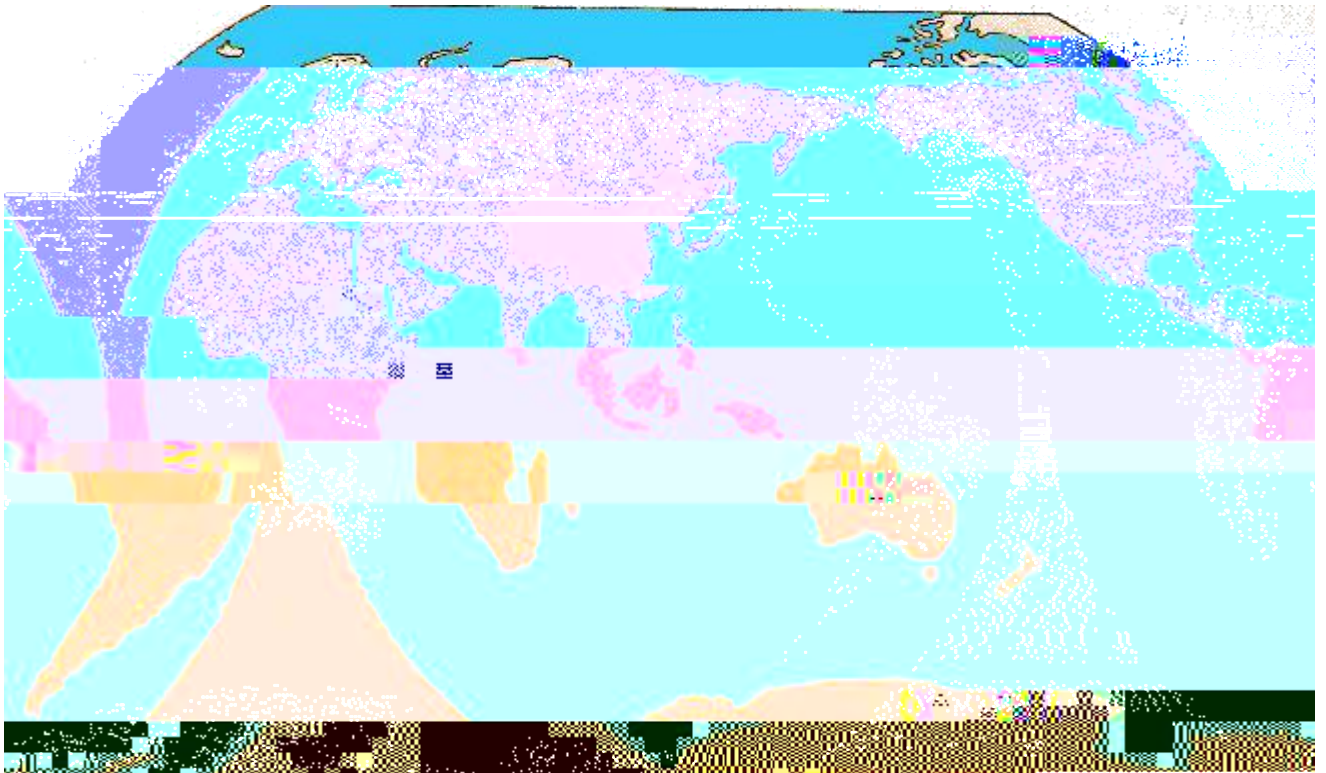

2

3-5

400

Word

2

--	--	--

	2	30	
	1	30 40	
Office	5		
	30		
30	2		

3

60

4

(20)	5		5	0
	5		1	
	10		4	
		5		
		5		
(80)	20		5	
	20		1 2	
	10		1 2	
	10	3-5	1 2 3	
		1 2		
	20		1 5	

10.

2-10

1

1

3000

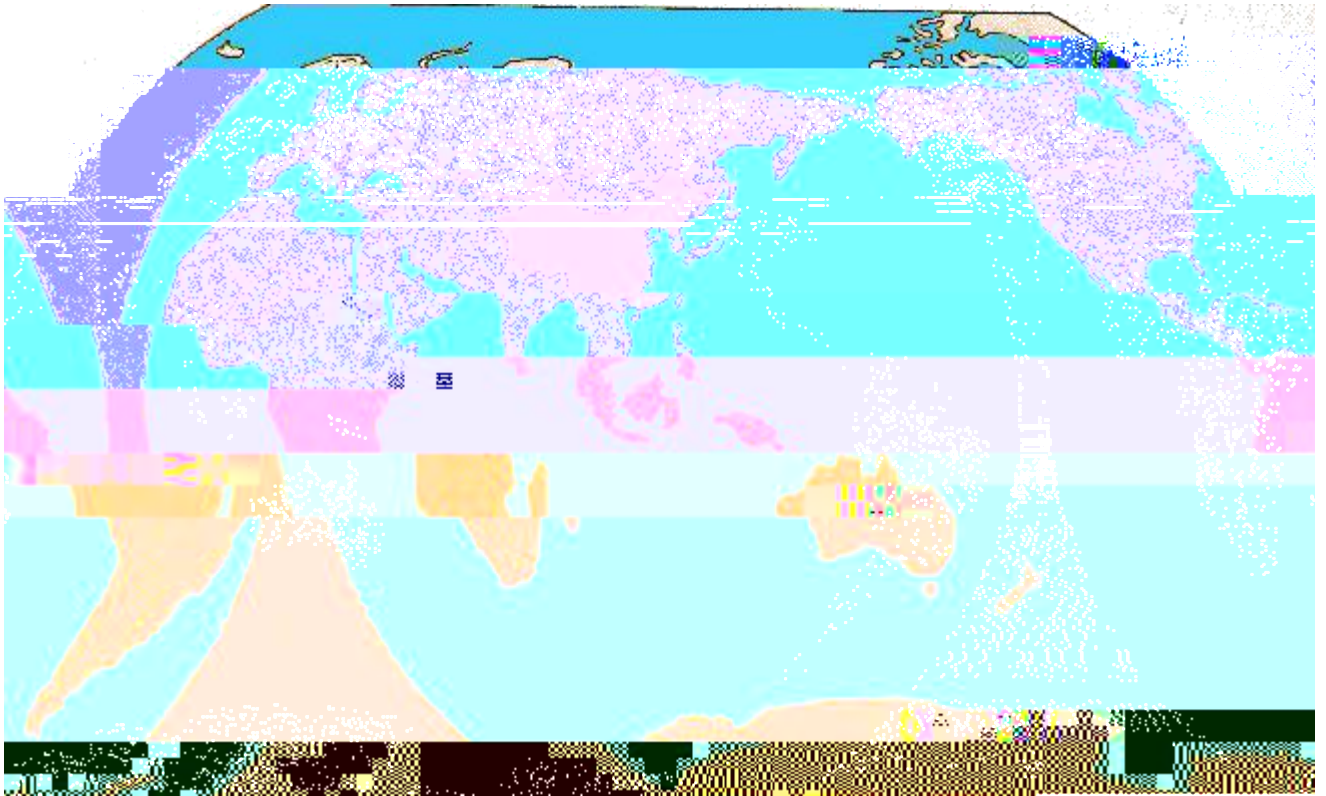

2

3-5

Wörd

2

--	--	--

	2	30	
	1	30 40	Office
	5		
		30	
	30	2	

3

60

4

(20)	5		5	0
	5		1	
	10		4 5 5	
(80)	20		5 5	
	20		1 2	
	10		1 2	
	10	3-5	1 2 3	
	20		1 2 1 5	

2-11

1

1

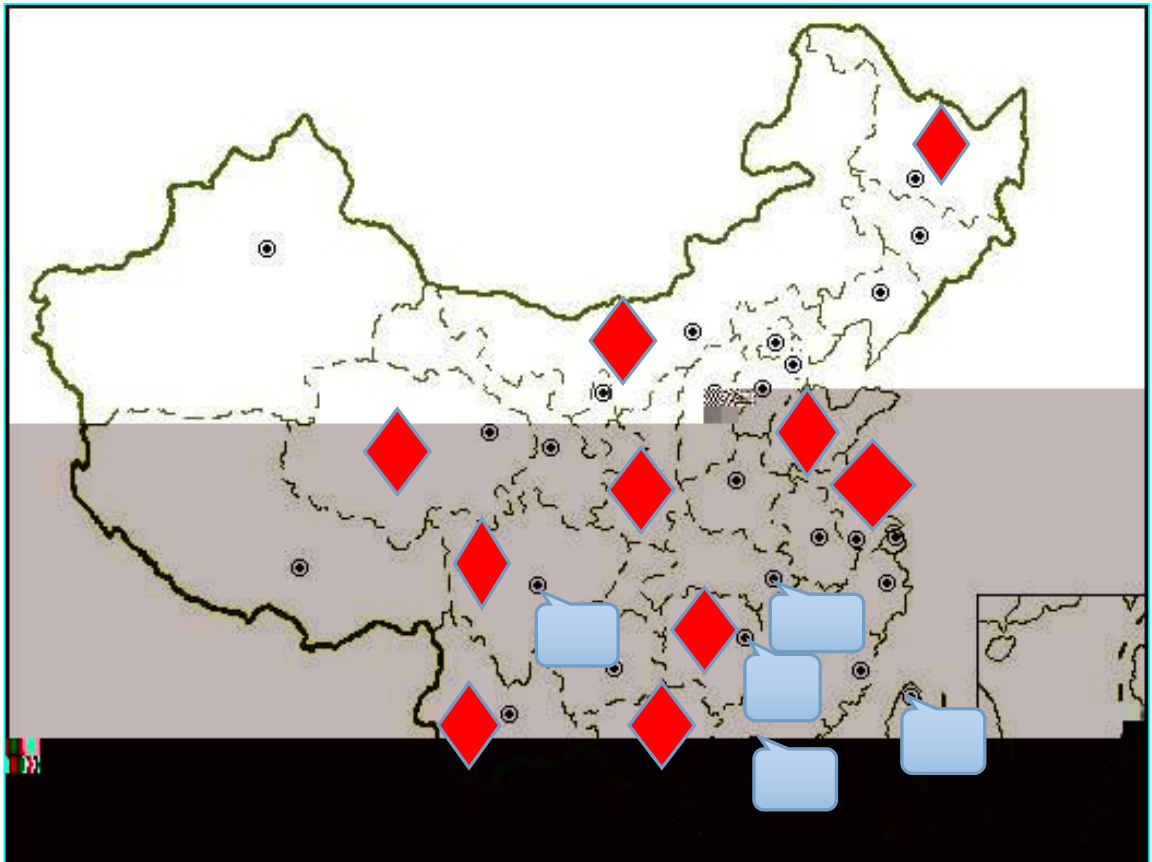

2

5

Wörd

2

	2	30
	1	30 40 Office
	5	
	30	
	30	2

3

60

4

(20)	5		5	0	
	5		1 4		
	10		5 5		
(80)	20		1 2 1 2		
	20		1 4 1 4		
	40				1 4
					1 4

12

2-12

1

1



2

G5513

Word

2

	2	30
	1	30 40 Office
	5	
	30	
	30	2

3

60

4

(20)	5		5	0
	5		1 4	
	10		5 5	
(80)	20		1 2 1 2	J1-32
	20		1 2 1 2	
	20	3-5	1 2 3 1 2	
	20		1 5	

13.

2-13

1

1)

17.5

2

Word

2

	2	30
	1	30 40 Office
	5	
	30	
	30	2

3

60

4

(20)	5		5
	5		1 4
	10		5 5

					0
(80)		30		1 10 1 10	
		30		1 10 1 10	
		20		1 5	

14. 2-14

1

1

30

400

Word

2

	2	30	
	1	30 40	Office
	5		
	30		
	30	2	

3

60

4

--	--	--	--	--

5

5

5

(20)

0

Word

2

	2	30
	1	30 40 Office
	5	
	30	
	30	2

3

60

4

(20)	5		5	0
	5		1 4	
	10		5 5	
(80)	30		1 5 1 5	
	30		1 5 1 5	
	20		5	

1.

3-1

1

1

4538kg

RMB145

RMB1.2/t•km

100

88
360km

100

2

20

10

20

*	*	*	*	*	*	*
				*		

--	--	--

"

"

10000

4‰

6000

15

15

2

	2	30
		1 30 40
	Offi ce	5
		30
	30	2

3

60

4

2

100

20%

80%

1

1

	5		5

(20)		5		1	0	
				4		
		10		5		
				5		
(80)		20		15		5
		15		10		5
		10				5 5
		15				8 7
		20		1		

2

3-2

1

1

25

5123kg

1.2 /t. km

330km

165 (

100

100

333)

$s \geq 300$

$w \leq 2$ 98%

$2 \leq w \leq 4$ 96%

$4 \leq w \leq 6$ 94%

$w \geq 6$ 92%

$s < 300$

$w \leq 2$ 100%

2<=W<4 98%

4<=W<6 96%

W=6 94%

2)

20

10

"

"

5000

4‰

300000

"

"

15

20

	<input type="checkbox"/>	<input type="checkbox"/>		<input type="checkbox"/>	<input type="checkbox"/>				
	<input type="checkbox"/>	<input type="checkbox"/>							
						<input type="checkbox"/>	<input type="checkbox"/>	<input type="checkbox"/>	<input type="checkbox"/>

	2	30
	1	30 40
	Office	5
		30
	30	2

3

60

4

2

100

20%

80%

1

1

(20)	5		5	0
	5		1	
	10		4 5	
(80)	20		5	
	15		15	
	20		1	
	15		15	
	10		10	

3

3-3

1

1

2010 8 12

500

160ml

15kg

500

0.4 /

1‰

2010 8 15

2010 8 16

2

10

20

15

*	*	*	*	*	*	*
*		*		*		

--	--	--

15

20

2

	2	30
		1 30 40
	Office	5
		30
	30	2

3

60

4

2

100

20%

80%

1

1

(20)	5		5
	5		1
	10		4 5

				5	0
(80)		15		2	8
		20		15	5
		15			
		20		10	10
		10			10

4. 3-4

1

1

8

145000

6.58%

25309.12

1000

300 /

0.3 /

7

300 / × 8 ×

8

4

8

=19200

2000

320

500

200

10%

19200

× 10% 1920

2

1920 ÷ 2

960

2000

800

48

258

665

2

20

				17.04

				5
			4	8
			1920	/
			923	
			48	/
				2000
				320
				2000
				500
				800
				200
				1000
			8	

15

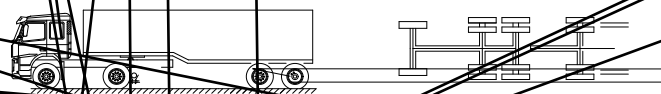
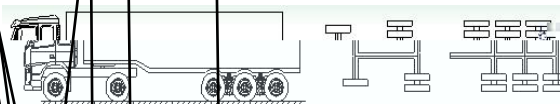

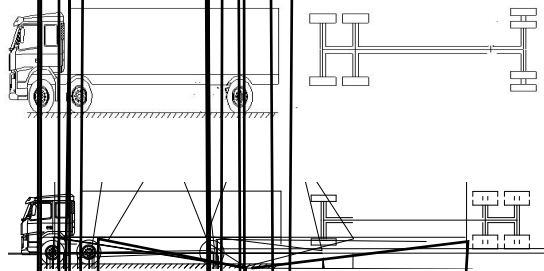

(20)		5		1	0
				4	
	10			5	
				5	
	15			5 10	
	20			1.5 2 2.5	
	15			3	
	15			15	
	15			15	

5. 3-5

1

1

QH1011100012

95

		35
		20
		20

KS1011150008

64

--	--	--

		35
		20
		10

DD1011150012

102

		30
		35
		30

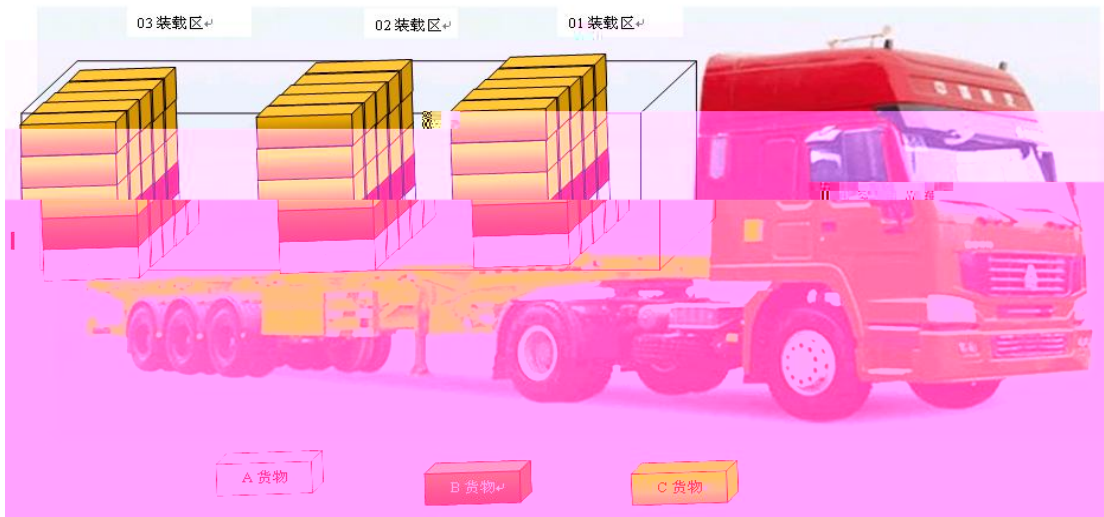

2)

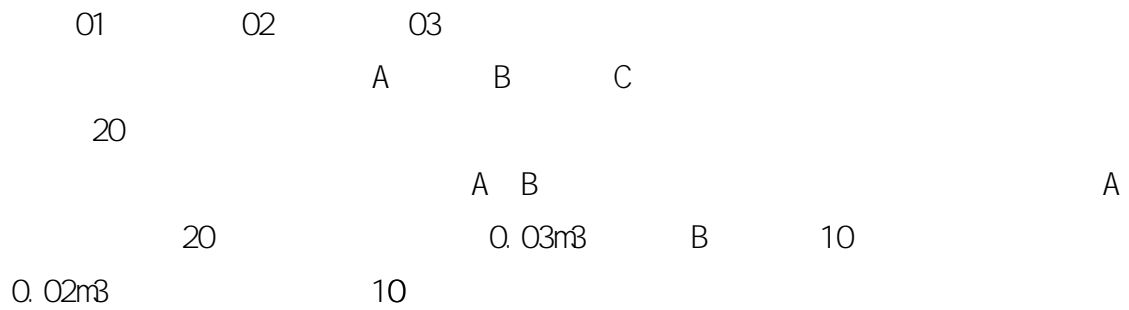

10

2

	2	30
	1	30 40
	Office 5	
	30	
	30	2

3

60

4

2

100

20%

80%

1



1

(20)	5		5	0
	5		1	
	10		4 5 5	
(80)	20		10 10	5
	20		15	

	<input type="checkbox"/>	<input type="checkbox"/>			<input type="checkbox"/>	<input type="checkbox"/>			
	<input type="checkbox"/>	<input type="checkbox"/>							
							<input type="checkbox"/>	<input type="checkbox"/>	<input type="checkbox"/>

D

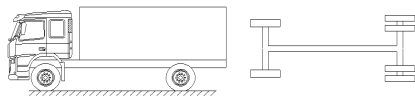
15

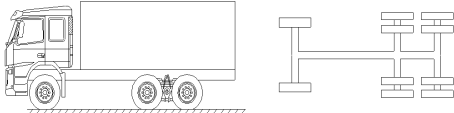
10

2

	2	30	
	1	30 40	
	5	Office	
	30		

	30	2	
--	----	---	--

3

60

4

2

100

20%

80%

1

(20)	5		5	0
	5		1 4	
	10		5 5	
(80)	15		10 5	
	20		15 5	
	20		2	
	15		2 15	
	10		5 5	

7. 3-7

1

1

T

" " "

"

1/3

" " "

" " "

2)

15

10

T

15

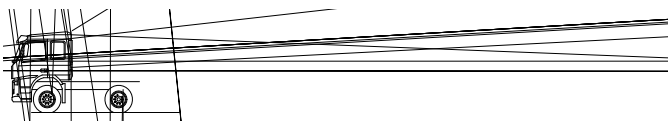
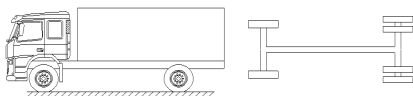

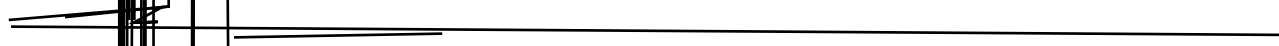
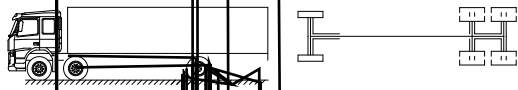

(20)	5		5	0
	5		1 4	
	10		5 5	
(80)	15		10 5	
	15		2 15	
	20		10 10	
	20		15 5	
	10		1.5 10	

8. 3-8

(1)

1
2010 11 6 10:00

SYTKH015

YD201010170004

10

0535- 6799811

89

0531- 86429521

100A45

40× 20× 15cm

1. 5kg 200

2. 4M

100B37

35× 25

× 10cm

1. 8kg

150

1. 3M

100C64

18× 26× 8cm

1kg

100

0. 4M

100D87

41× 22× 20 cm

1. 8kg

100

1. 8 M B
1. 2kg 100
100A45

100E28
0. 1 M B
10000

23. 4 \times 10. 5 \times 6. 6 cm
2010 11 7
0. 06%

13587890165

BXD101

9. 6

ZYTZD004

2010 11 7

2)

20

*		*									
*					*						
*			*	*	*	M B	*	*			
				kg							

20

						×	×

15

10

15

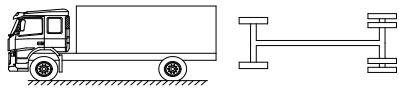

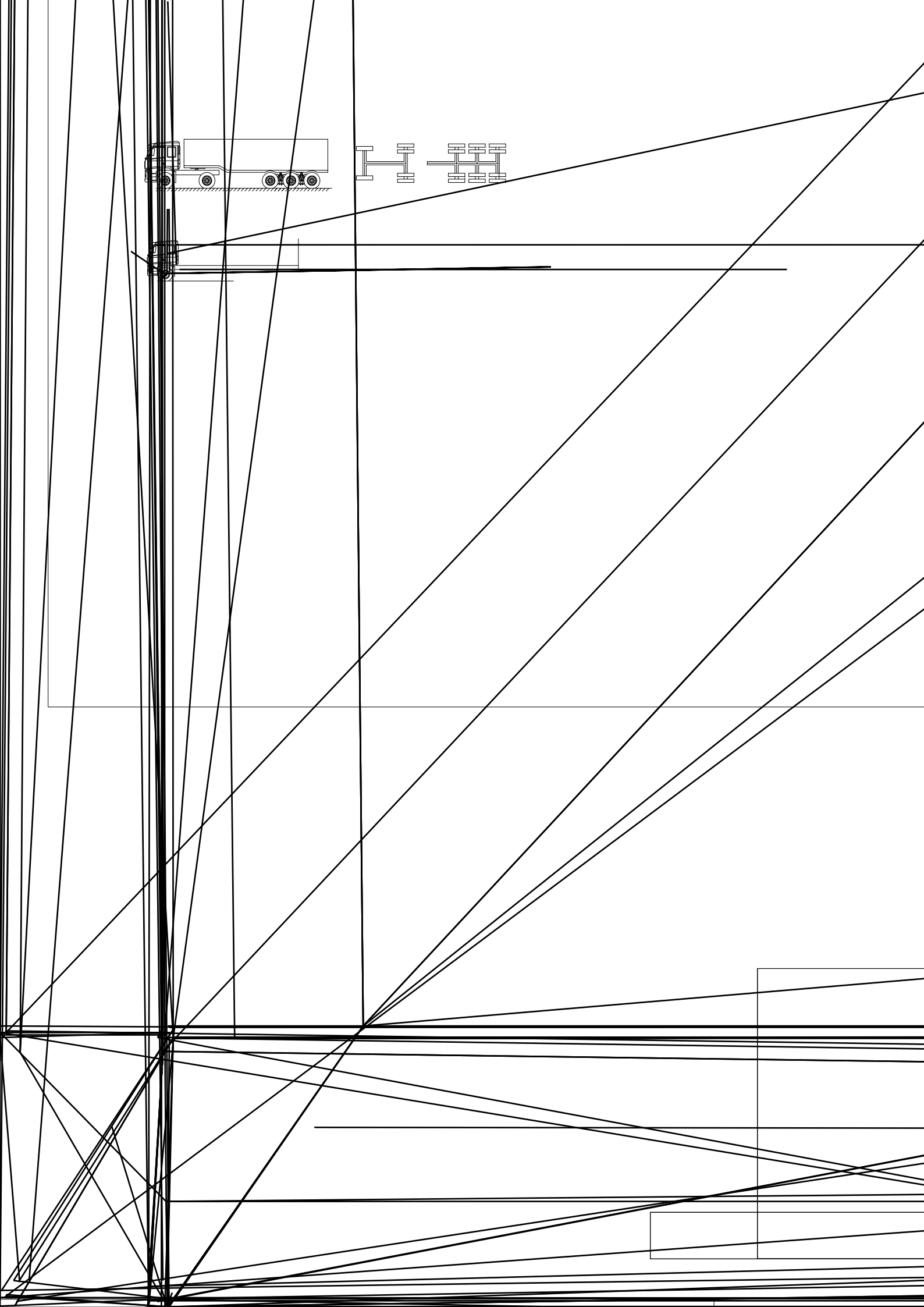
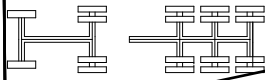
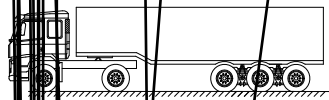
(20)	5		5	0
	5		1 4	
	10		5 5	
(80)	20		1	
	20		1	
	15		15	
	15		2	
	10		10	

9.

3-9

1

1

35

40000

7200

32000

2000

300 /

10

300 / × 35 × 6

3 6

=63000

5000

3000

3000

2

2100

600

105

374

726

2)

20

43.2

5

3

6

3000 /

374+726

105 /

5000

2100

3000

600

	2	30
	1	30 40
	Office	5
		30
	30	2

3

60

4

2

100

20%

80%

1

1

(20)	5		5	0
	5		1	
			4	
(80)	10		5	
			5	
	20		1.5 , 2 2.5	
	15		15	

		15		2	
		15		10	5
		15		10	5

10.

3-10

1

1

20t B6

1 9.2 /t 2

0.0506 / t km

2962km B6 38

30%

2)

20

15

10

20

15

2

	2	30
	1	30 40

	Office	5	
		30	
	30	2	

3

60

4

2

100

20%

80%

1

1

(20)		5		5
		5		1
		10		4
(80)		20		5
		15		15
		10		5
				0

		15		10	5
		20			8 2

11.

3-11

1

1

26t

60t

556km

6

6

1 14.6 /t

2

0.0704 / t km

2)

20

15

10

15

20

2

	2	30
		1 30 40
	Office	5
		30
	30	2

3

60

4
20% 2 80% 100
1
1

12

3-12

1

1

HF

GUANGZHOU HF Trading CO., LTD.

Room 502, No. 838, Dongfeng Road, Guangzhou, Chi na

TEL: 020-87656751 FAX: 020-87656772

AL QADAH TRADING COMPANY L. L. C

202 W 1st St. LOS ANGELES, CA 90012

Phone (877) 554-4000 Fax (213) 237-3535

PRODUCT: CLEANING BALL

PARTIAL SHIPMENT allowed

TRANSSHIPMENT : allowed

TIME OF SHIPMENT() 2016 5 15

SERVICE TYPE() CY/CY

FREIGHT() PREPAID

PORT OF LOADING() SHENZHEN

PORT OF DISCHARGE() LOS ANGELES

USD1450/20GP, USD1800/40GP, USD1800/40HQ

--	--	--

COSCO CONTAINER LINES

序列号	航线	船名	航次	截关时间	装货港	预计高港时间	实际高港时间	卸货港
<p>Sailing Schedule from : Shenzhen,Shenzhen,Guangdong,China To : Los Angeles,Los Angeles,CA,United States Origin City : Shenzhen,Shenzhen,Guangdong,China Destination City : Los Angeles,Los Angeles,CA,United States</p> <p style="text-align: right;">CY/DOOR CY/DOOR</p>								
1	YPSW	YM UNISON	59E	2016-04-22 17:00	Yantian	2016-04-25		Los Angeles
2	SEA	NORTHERN JAVELIN	002E	2016-04-23 12:00	Yantian	2016-04-27		Long Beach
3	AAS2	CMA CGM LIBRA	095TXE	2016-04-25 16:00	Yantian	2016-04-28		Long Beach
4	YPSW	YM UBIQUITY	22E	2016-04-29 17:00	Yantian	2016-05-02		Los Angeles
5	SEA	CSCS PUSAN	117E	2016-04-30 12:00	Yantian	2016-05-04		Long Beach
6	AAS2	CMA CGM COLUMBA	097TXE	2016-05-02 16:00	Yantian	2016-05-05		Long Beach
7	SEA	COSCO NINGBO	069W	2016-05-06 11:00	Yantian	2016-05-08		Long Beach
8	YPSW	YM LIBERTY	50E	2016-05-06 17:00	Yantian	2016-05-09		Los Angeles
9	SEA	COSCO EXCELLENCE	027E	2016-05-07 12:00	Yantian	2016-05-11		Long Beach
10	AAS2	CMA CGM CENTAURUS	099TXE	2016-05-09 16:00	Yantian	2016-05-12		Long Beach
11	YPSW	YM MASCULINITY	32E	2016-05-13 17:00	Yantian	2016-05-16		Los Angeles
12	SEA	HONG KONG BRIDGE	039E	2016-05-14 12:00	Yantian	2016-05-18		Long Beach
13	AAS2	CMA CGM THALASSA	101TXE	2016-05-16 16:00	Yantian	2016-05-19		Long Beach

COSCO CONTAINER LINES

干货箱



	箱体内部尺寸			箱体内容及载重量		箱门开度尺寸	
	L	W	H	Cu	P	W	H
20'	5898	2352	2393	33.2	21740/28230#	2340	2280
40'	12032	2352	2393	67.7	26630	2340	2280
HC	12032	2352	2698	76.3	26520	2340	2585

冷藏箱



	箱体内部尺寸			箱体内容及载重量	
	L	W	H	Cu	P
20'	5444	2284	2267	28.5	21135/27160#
40'	11583	2284	2250	58.7	26580

开顶箱



	箱体内部尺寸			箱体内容及载重量	
	L	W	H	Cu	P
20'	5898	2352	2393	33.2	21740
40'	12032	2352	2393	67.7	26630

2

	2	30	
	1	30 40	Office
5			
	30		
	30	2	

--	--	--

3

60

4

2

100

20%

80%

1

				1
			"	"

13.

HD

?

200 37% WMO 10 28% 25% 1m3

HOUSE B/L MASTER B/L HOUSE B/L,

2

	2	30
	1	30 40 Ofi ce
	5	
	30	
	30	2

3

60

4

20% 2 100 80%

1

7

3

4

HOUSE B/L MASTER B/L

14. 3-14

1

1

LX

DO

(computer parts)

2014 10 7 20 00

60X50X40CM

10kg/

16000 /

5

PEK				LAX		

2)

		<input type="checkbox"/>	<input type="checkbox"/>	<input type="checkbox"/>	<input type="checkbox"/>

<input type="checkbox"/>	<input type="checkbox"/>			
<input type="checkbox"/>	<input type="checkbox"/>			

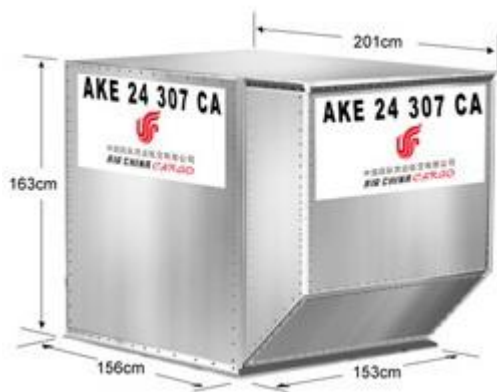

2

	2	30
	1	30 60

	5	Office	
		30	
	30	2	

3
60
4
2 100
20% 80%
1

2

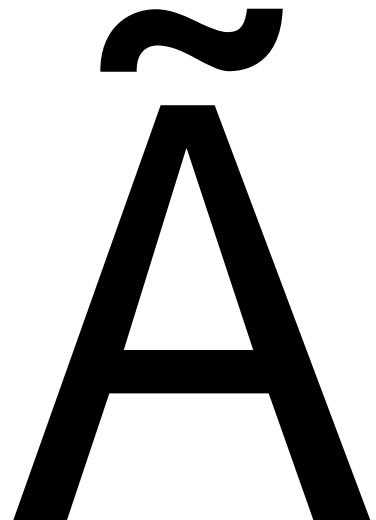

15.

3-15

1

1

Taps

35.6

BEI JI NG	CN		BJS
Y. RENMI NGBI	CNY		KGS
SI NGAPORE	SN	M	200
		N	30.5
		45	22.49

6000 cm³ /kg ,

0.5

2)

--	--	--	--	--	--

2

		2		30	
			1	30	60
		5			Office
			30		
		30	2		

3

60

4

2

100

20%

80%

1

				10	
				5	
				2	

1. 4-1

1

() 20

50

40

1

()

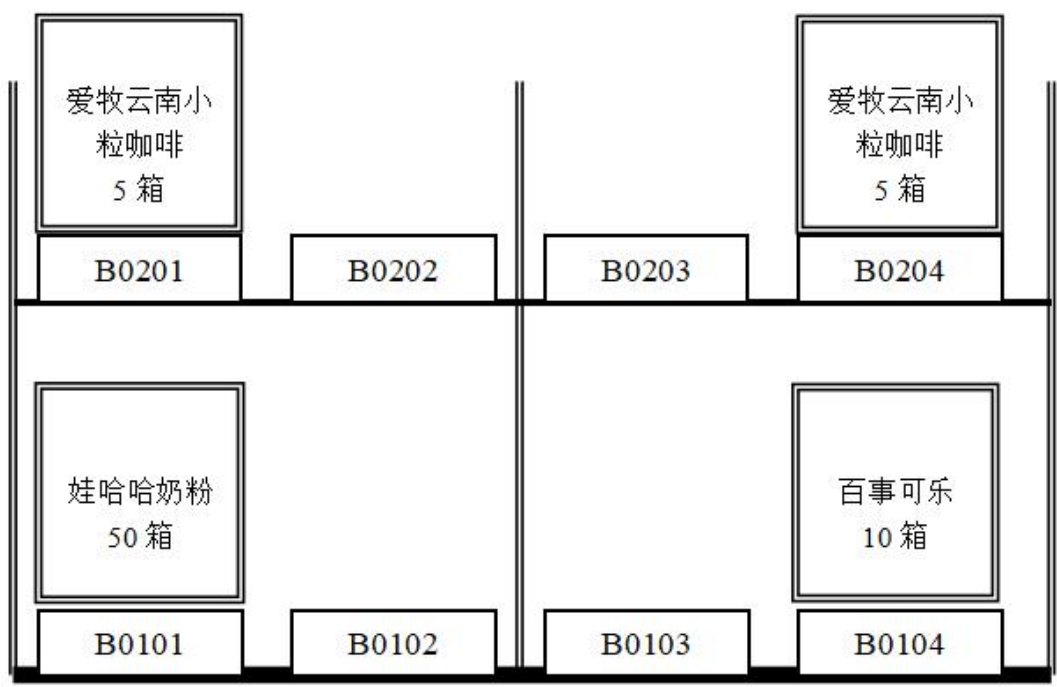
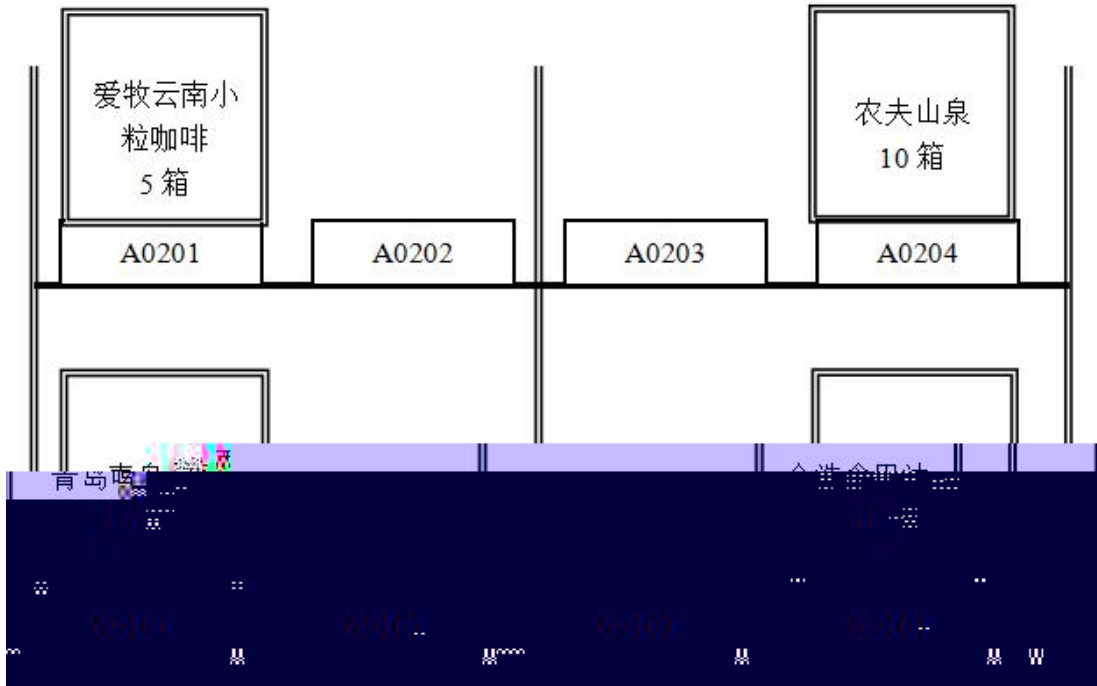

1							
2	()						

- ①
- ②
- ③
- ④
- ⑤
- ⑥
- ⑦
- ⑧

RF

RF

RF

RF

2

	2	2	2×2		1		1
			2		1	1	1
		1		1	RF		2
	2		1		1		
	1200×	1000×	144 mm		10		

--	--	--

3

60

4

				—
				—
				—
				—
				-5
				-5
				-5
				—

2

4-2

1

40

40

20

1

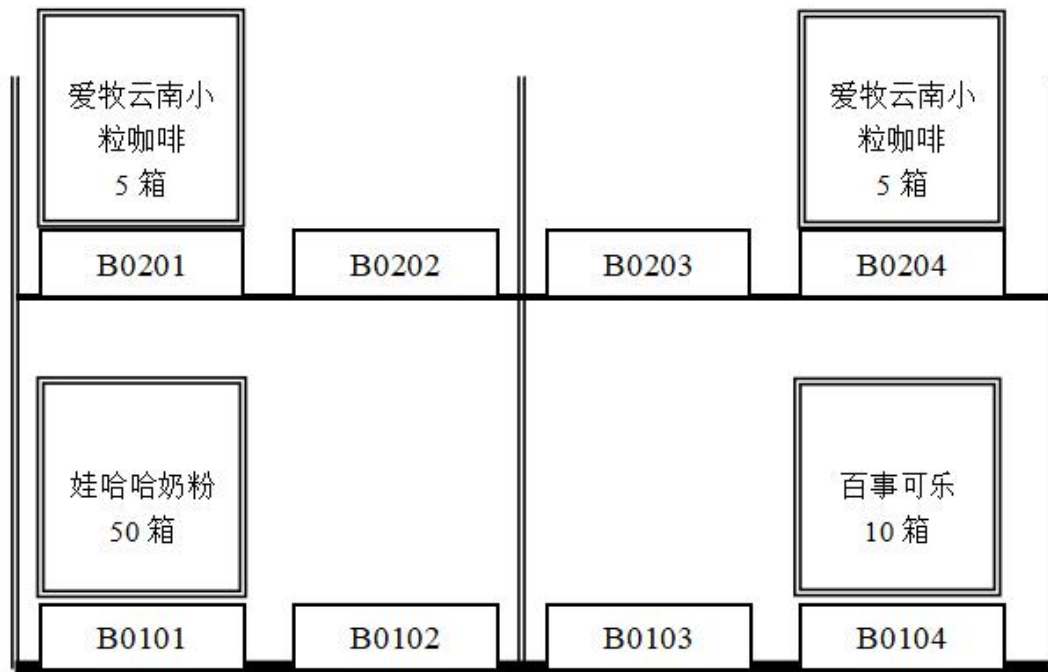
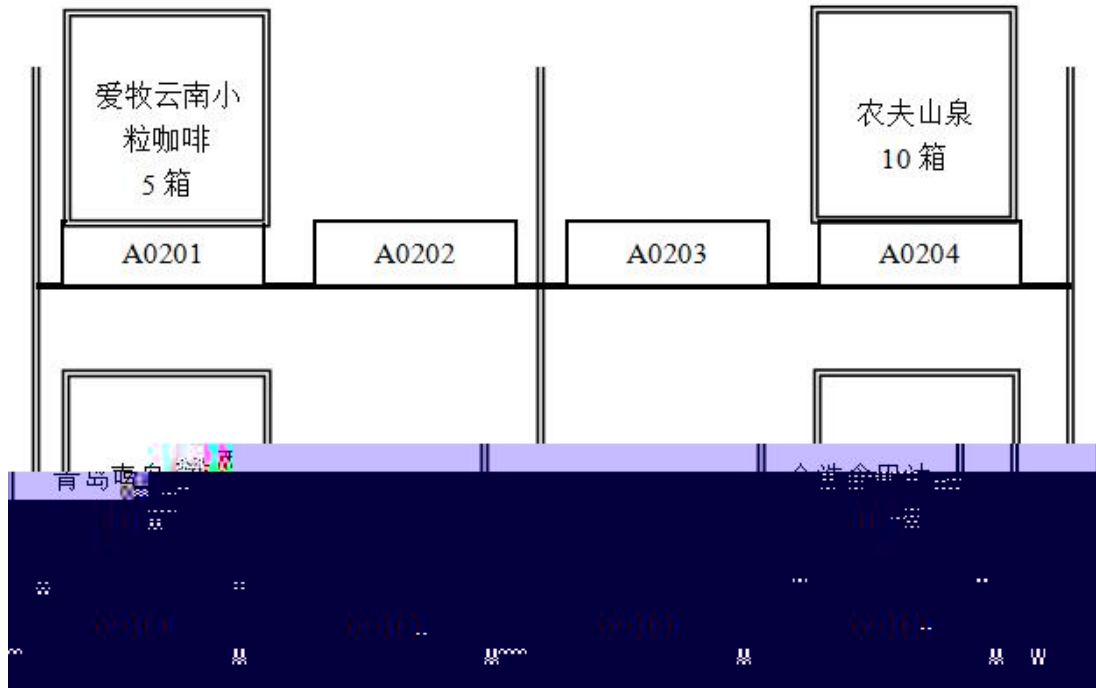

1			40				
2				330ml			
				330ml			

RF

RF

RF

RF

2

	2	2	2× 2			1		1	
			2		1		1	1	
		1		1	1	RF		2	
	2			1		1			
	1200× 1000× 144 mm				10				

--	--	--

3

60

4

			—	
			—	
			—	
			—	
			-5	
			-5	
			-5	
		—		

3.

4-3

1

20

40

30

1

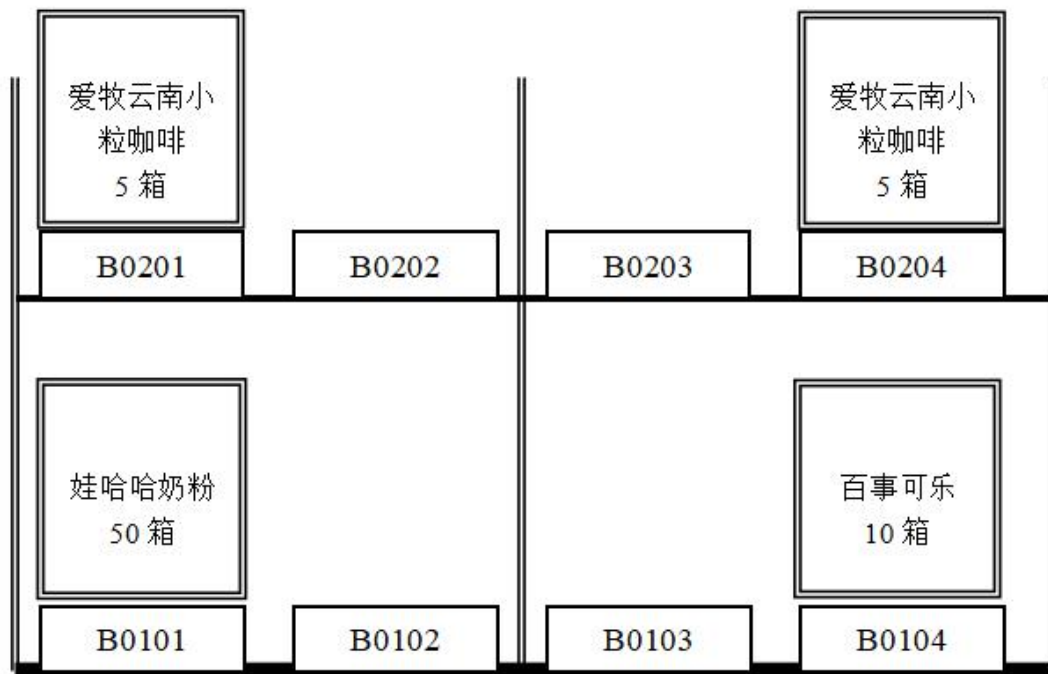
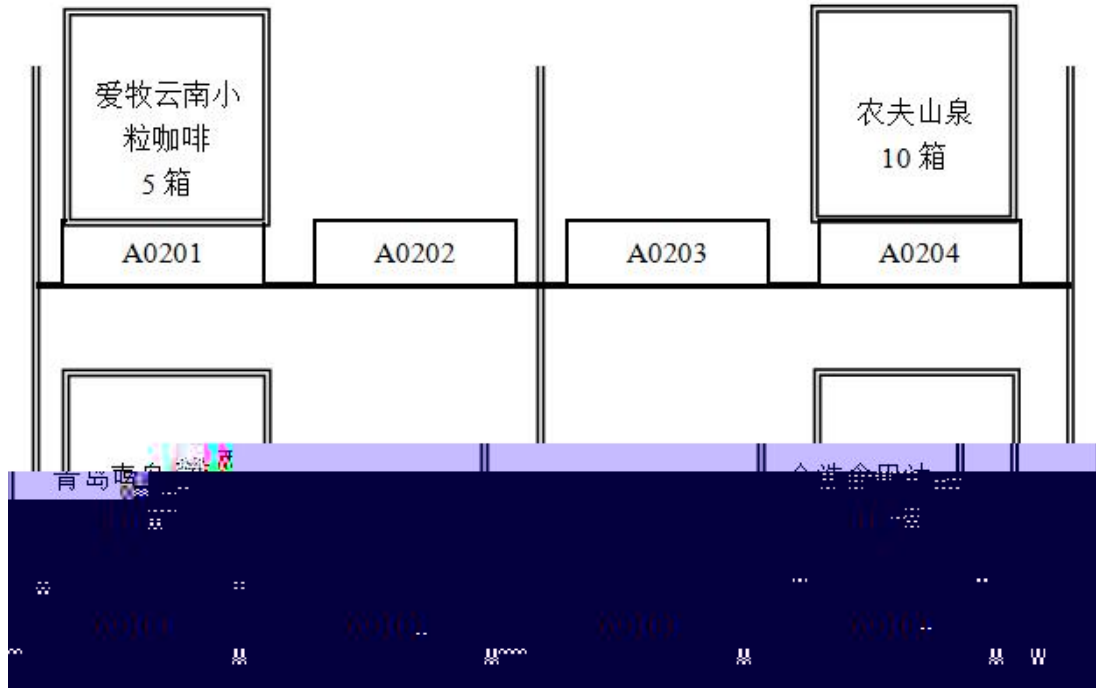

--	--	--

3

60

4

		-		
		-		
		-		
		-		
				-5
				-5
				-5
				-5
-				

4.

4-4

1

40

30

30

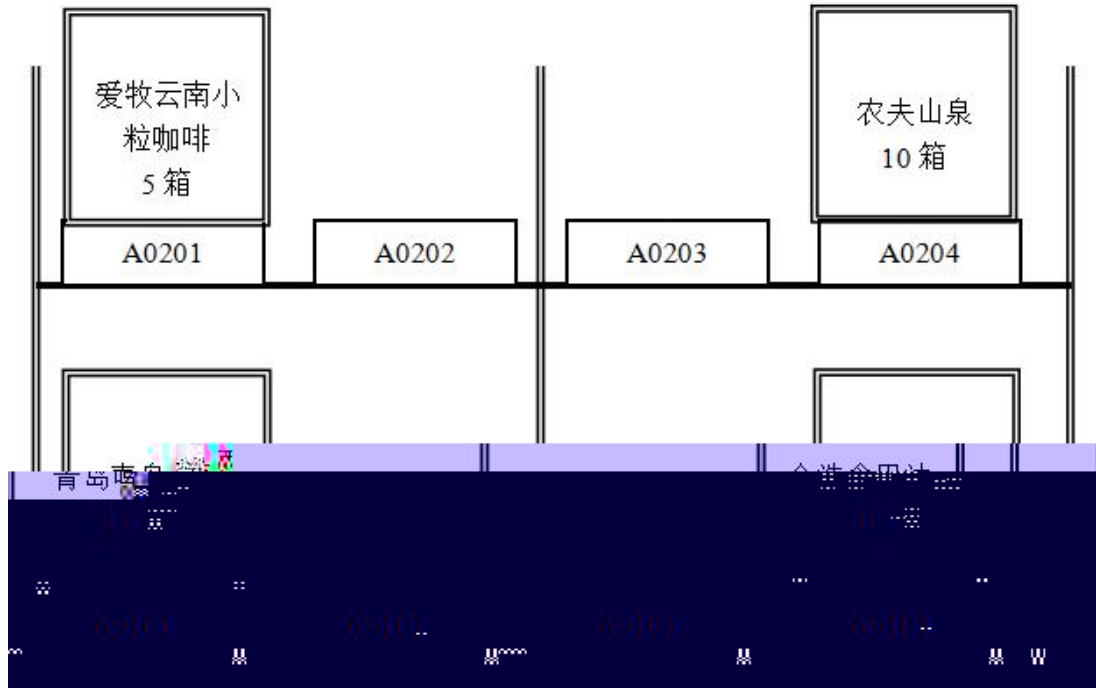

1							
2							
3							

RF

RF

RF

RF

2

	2 2 2x 2 1 1 2 1 1 1 1 1 1 RF 2 2 1 1	
	1200x 1000x 144 mm 10	

--	--	--

3

60

4

				—
				—
				—
				—
			-5	
			-5	
				-5
		—		

5.

4-5

1

40

40

20

1

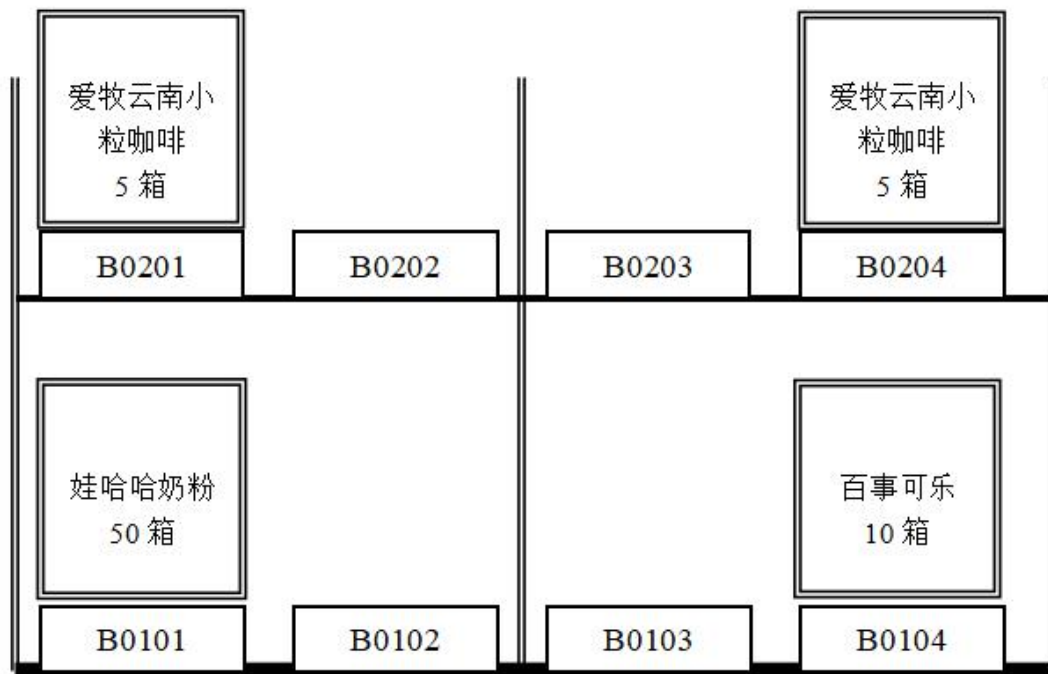
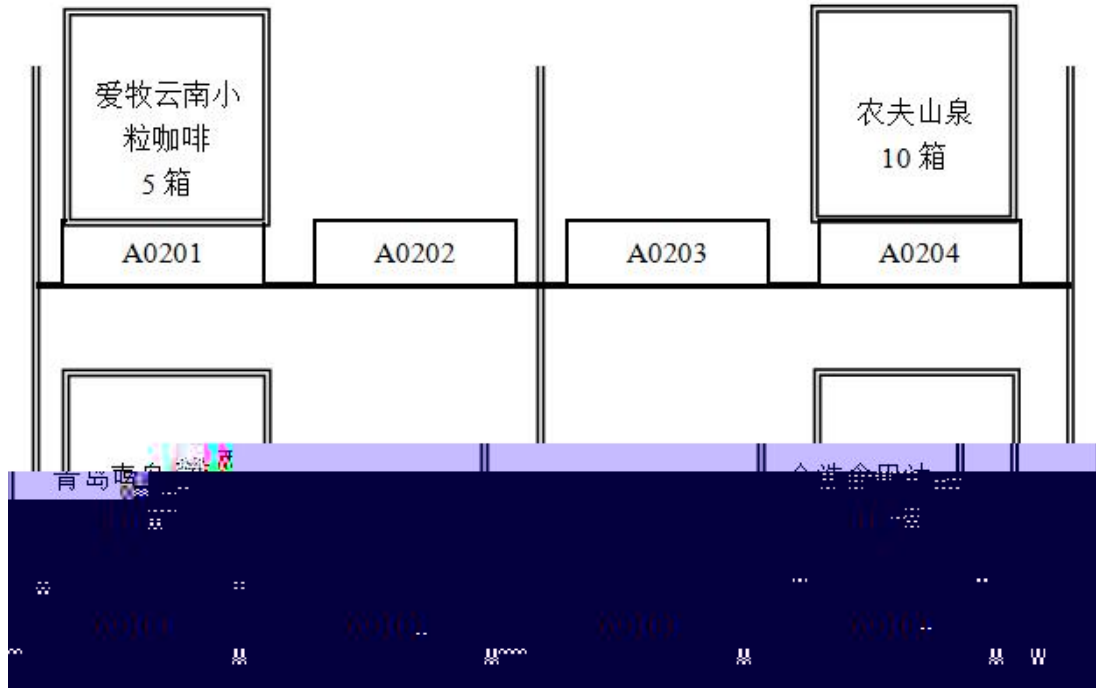

1	()						
2							

RF

RF

RF

RF

2

	2	2	2x 2			1		1	
			2		1		1	1	
		1		1	1	RF		2	
	2			1		1			

	1200× 1000× 144 mm	10	

3

60

4

			—	
			—	
			—	
			—	
				-5
				-5
				-5
			—	

6.

4-6

1

			()		
1			2	3	
2			298	4	
3			5	2	
		---	---		

2015. 10. 26

			()		
1			2	2	
2			298	5	
		---	---		

2015. 10. 26

			()		
1			2	2	
2			298	6	
3			5	1	

--	--	--	--	--	--

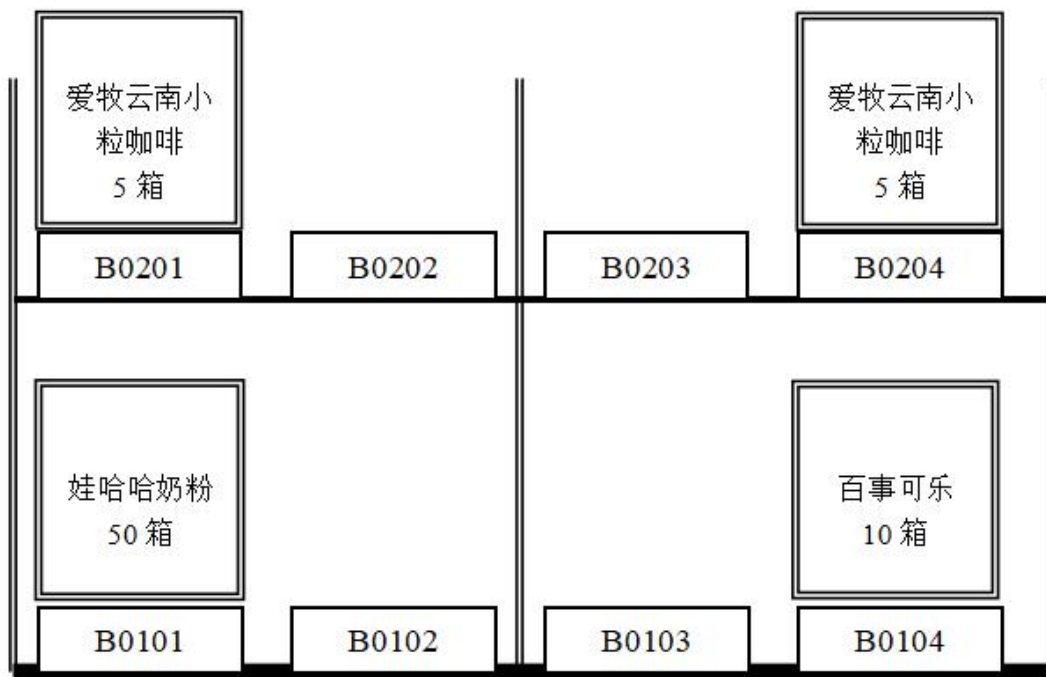
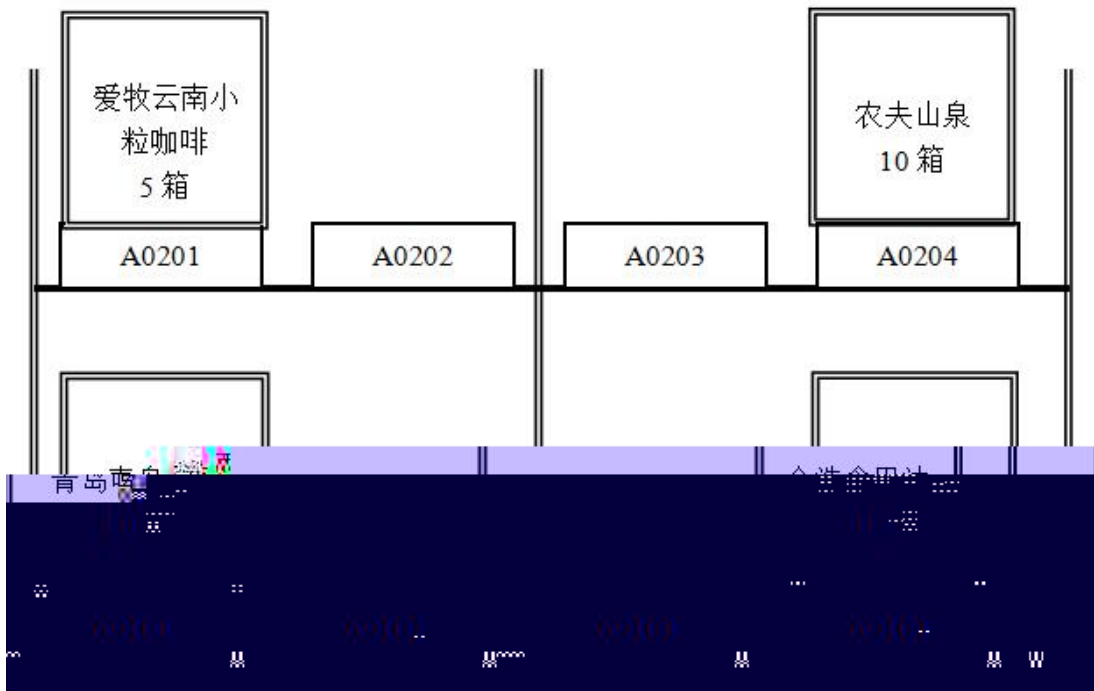

- a. WWS
- b.

- c.
- d.
- e
- f.
- g.
- h.

RF

			()		
1			4.5	3	
2			2	4	
3			3	5	
4			3	2	

- a.
- b
- c.
- d.

2

	1						
	2	2	2x 2		1		1
			2	1	1		1
	1		1	1	RF	2	

	2	1	1	
	1200× 1000× 144 mm	10	10	
	2	1		

3

60

4



3

2

20

5

7S

7S

10

0



				3		
	10			2		
				2		
	10		VWS	6	2	2
				2		
	10			3	2	3
				2		
30	5			2		
			(VWS)	1	2	
	15		(DPS)	2	8	
					2	3
	10			2		4
				4		
			2			

7.

4-7

1

			()		
1			2	3	
2			298	5	
3			3	1	
		---	----		

			()		
1			2	3	
2			298	6	
3			3	2	
		---	----		

			()		
1			2	4	
2			298	1	
3			3	4	
		---	----		

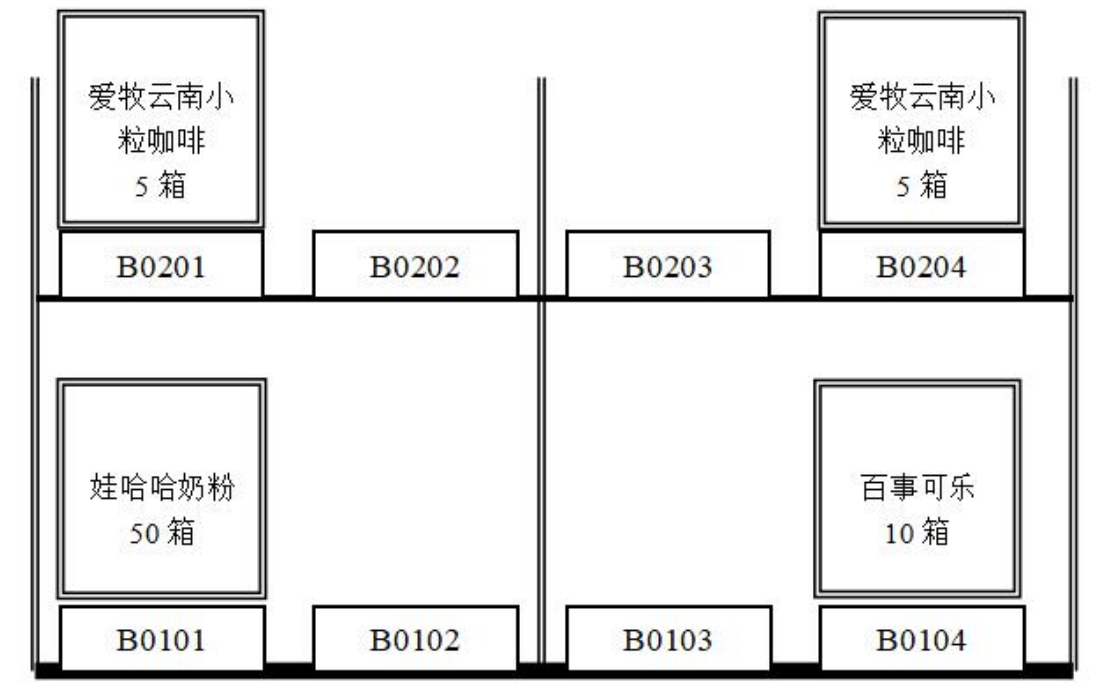
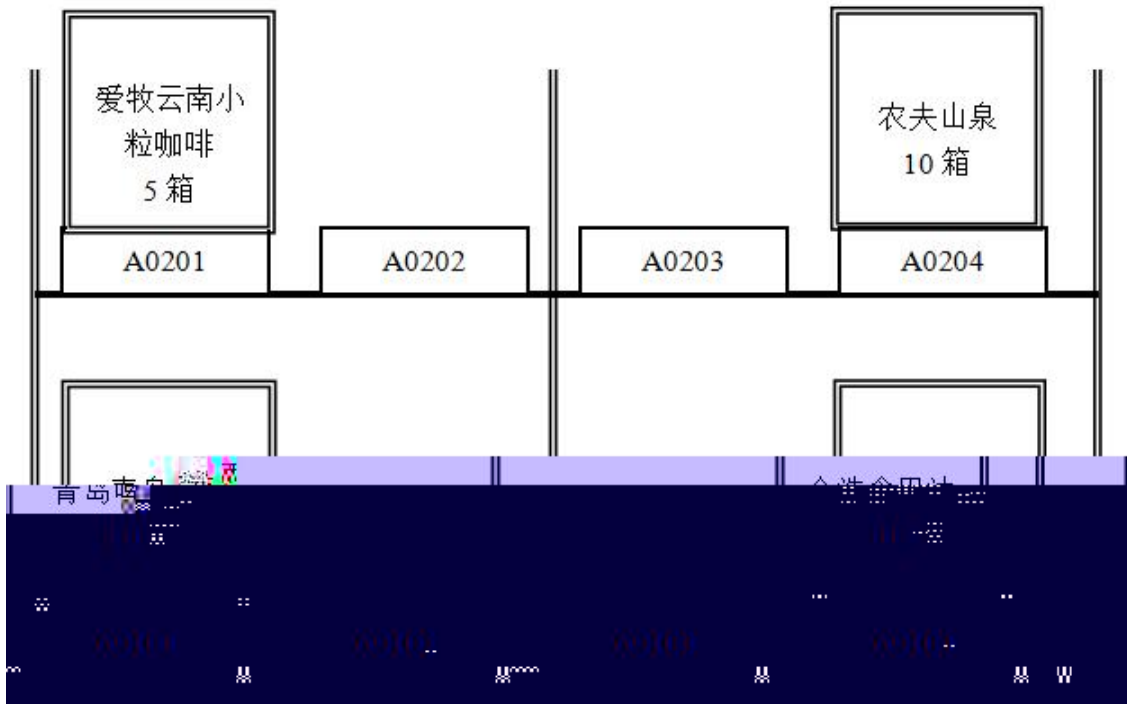

a. W\$

b.

c.

d.

e. RF

f.

g.

h.

			()		
1			5	2	
2			2	3	
3			4.5	3	
4			3	1	
		---	---		

a.

b.

c.

d.

		1					
	2	2	2x 2		1		1
			2		1		1
		1		1	RF		2
	2		1		1		
	1200x	1000x	144 mm		10		10
			2		1		

3

60

4

					3	
		20				2
						5
			7S		7S	10
						1
		5				2
						2
			VWS		1	2
		5			2	
						1
50				VWS		4
		5			1	
			VWS			
						0

	15		2	
		(RF)	2	
			2	1 3
		(RF)	1 3	RF
			3	
	10		2	
				2
		6		
		2		
	10	VWS		2
				3
		3		
				2
30	5			2
		(VWS)	1	2
	15	(DPS)	2	8
				2
				3
			2	
10				4
			4	
				2

8.

4-8

1

			()		
1			60	2	
2			298	2	
3			3	1	
		---	---		

			()		
1			298	3	
2			3	1	
		---	---		

			()		
1			60	3	
2			298	3	
3			3	1	
		---	---		

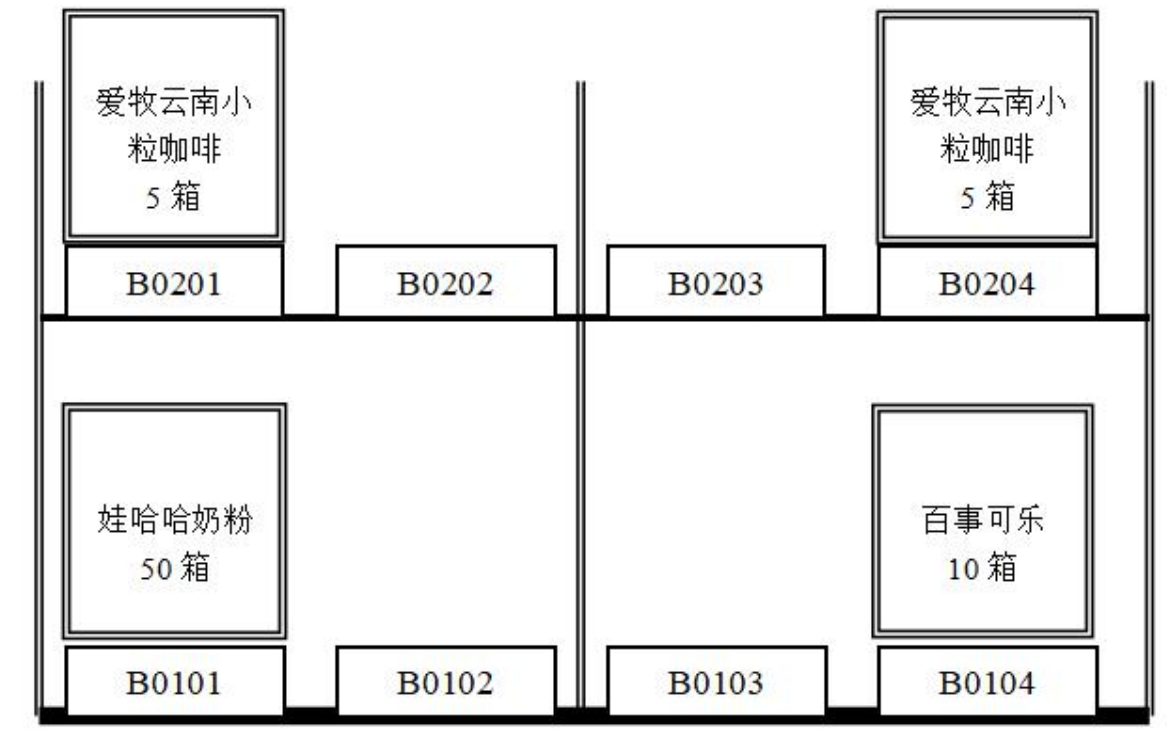
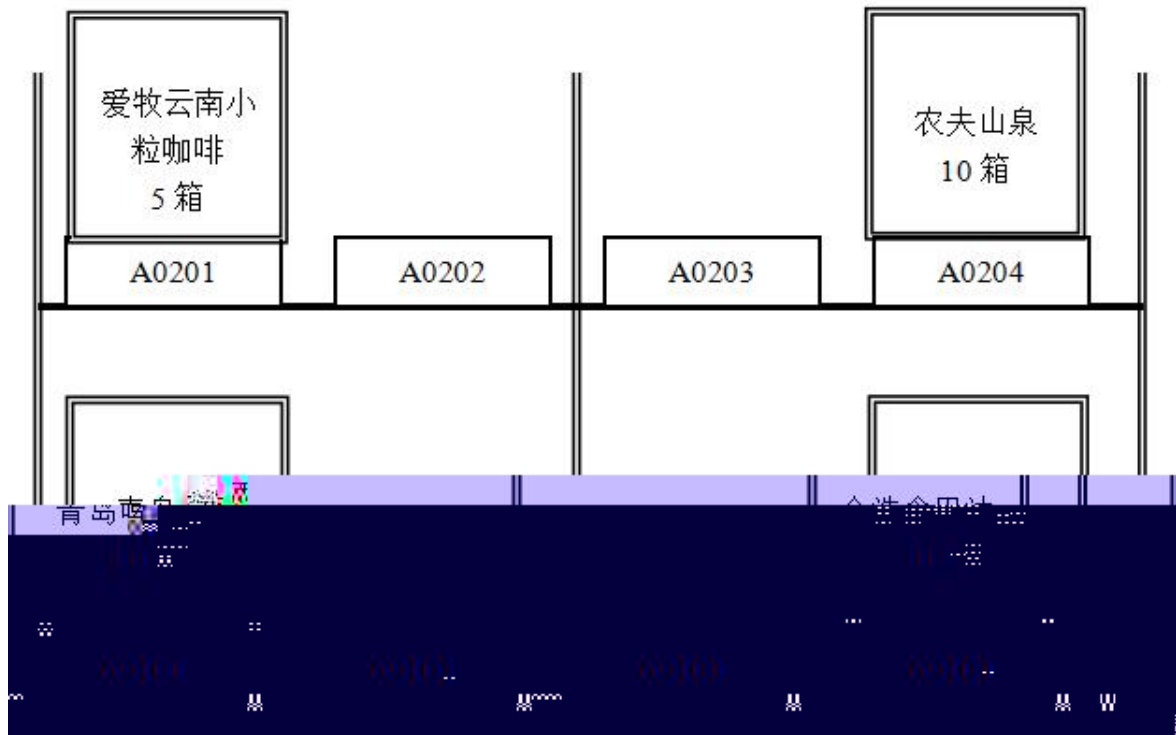

a. W&S

b

c.

d.

e.

RF

f.

g.

h.

			()		
1			5	1	
2			2	3	
3			3	2	
4			3	2	
		---	---		

a.

b

c.

d.

		1						
	2	2	2× 2		1		1	
			2		1		1	1
		1		1	1	RF	2	
	2			1		1		
	1200×	1000×	144 mm		10		10	
			2		1			

3

60

4

		20			3		2
							5
			7S		7S	10	
		5				1	2
							2
		5	VW\$		1	2	
					2		
50						1	
		5		VW\$			4
							0

			VWS	1	
		15		2	
			(RF)	2	
				1 3	
			(RF)	1 3 RF 3	
		10		2	
				6 2	2
		10	VWS		2 3
				3	
30		5			2
			(VWS)	1	2
		15	(DPS)	2 8	
					2 3
				2	
		10			4
			4	2	

9.



2			298	4	
3			3	2	

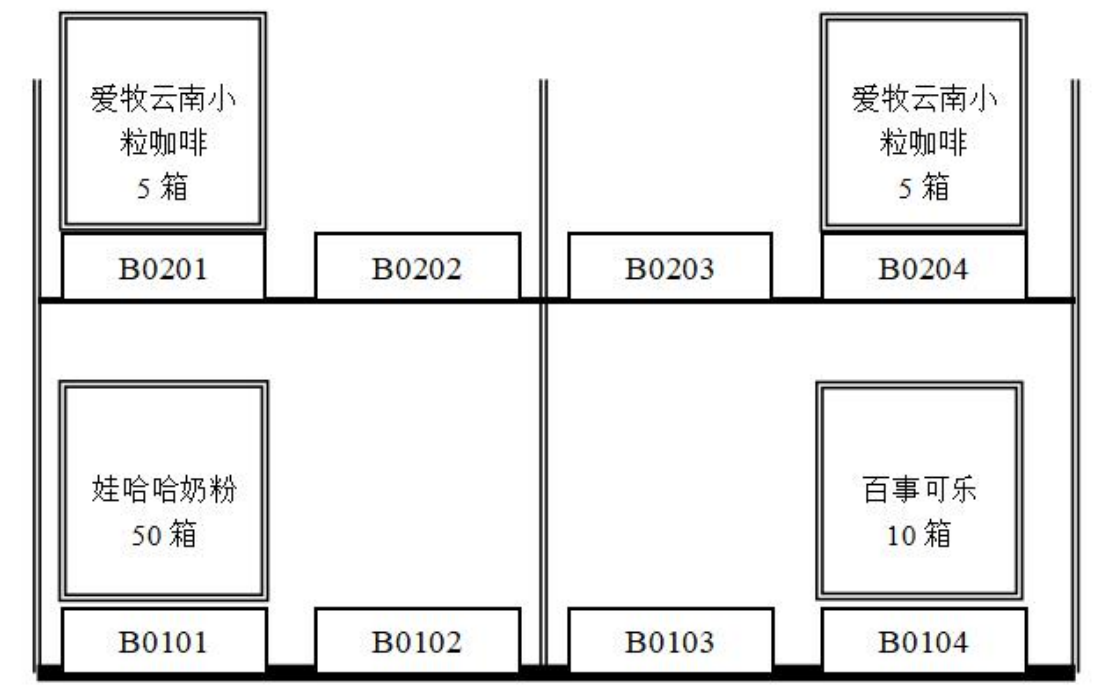
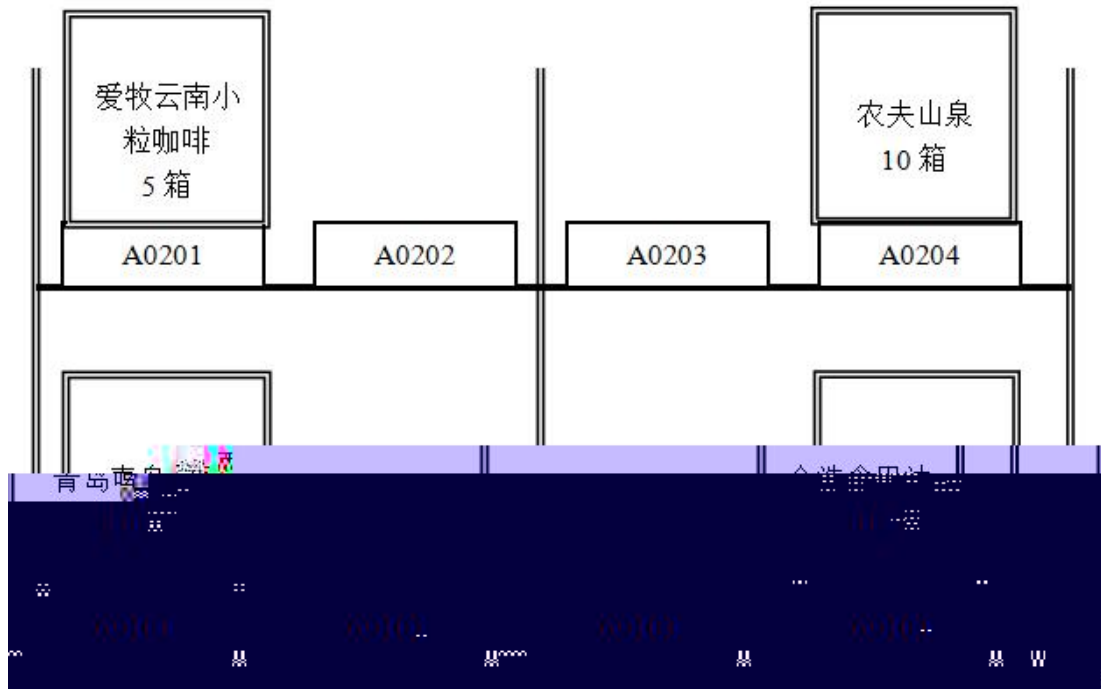

a. $\mathbb{W}\$$

b.

c.

d.

e.

RF

f.

g.

h.

			()		
1			2	2	
2			2	4	
3			4.5	2	
		---	---		

a.

b.

c.

d.

2

--	--	--

	1	
	2 2 2x 2 1 1	
	2 1 1 1 RF 2 1	
	2 1 1	
	1200x 1000x 144 mm 10 10	
	2 1	

3

60

4

	20		3	0
			2	
			5	
		7S	7S 10	
50	5		1	
			2 2	
	5	WWS	1 2	
			2 1	
	5	WWS	4	
		WWS	1	
15		2		
	(RF)	2 2		

				1	3		
			(RF)	1	3		
	10			RF	3		
				3			
	10			2			
				2			
10	VW\$		6				
			2				
30	5				2		
			(VW\$)	1	2		
	15		(DPS)	2	8		
					2		3
	10			2			
					4		
			4				
			2				

10.

4-10

1

			()		
1			60	3	
2			298	2	
3			3	2	
		---	---		

			()		
1			60	2	
2			298	3	
		---	---		

			()		
1			298	4	
2			3	2	
		---	---		

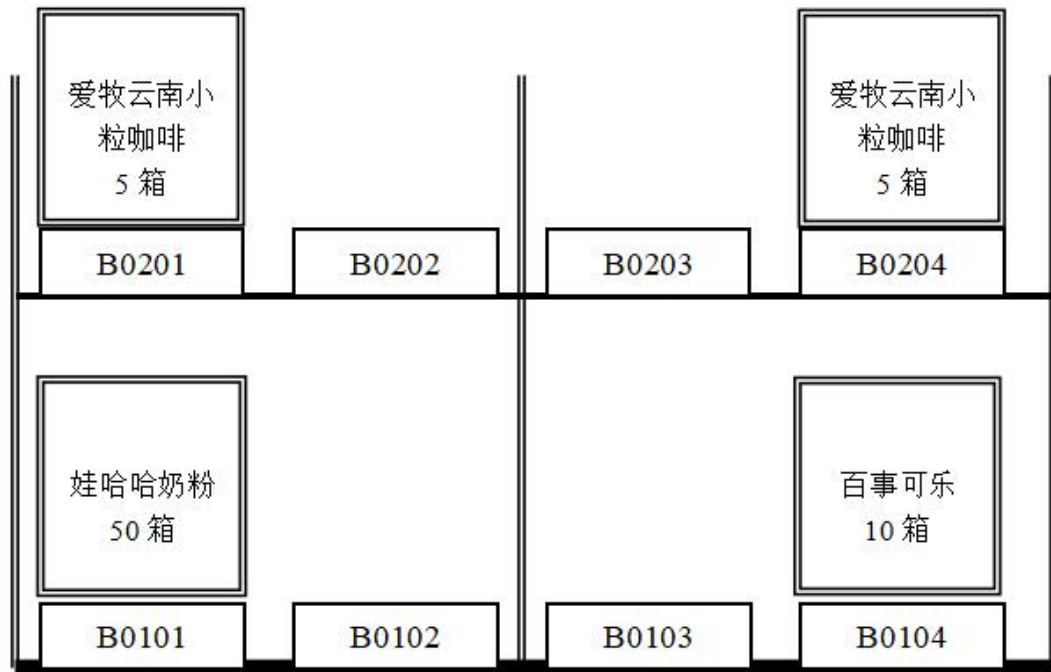
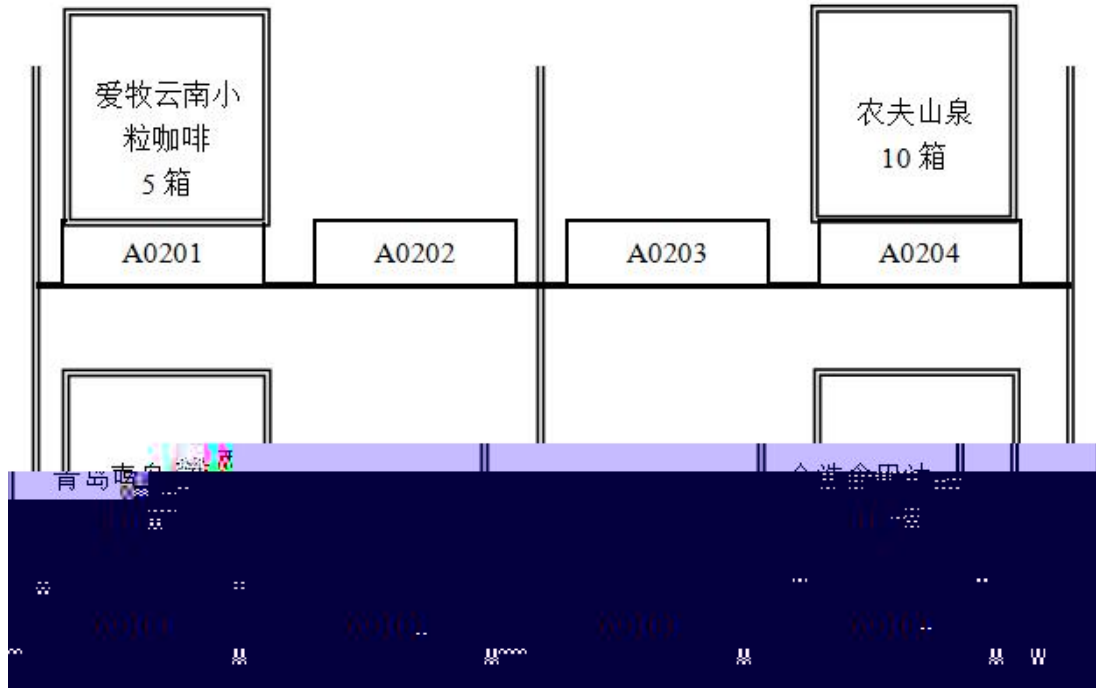

a. W\$

b

c.

d.

e.

RF

f.

g.

h.

			()		
1			4.5	2	
2			2	3	
3			3	1	
4			3	2	
		---	---		

a.

b

c.

d.



1
2 2 2×2 1 1
2 ê 1 1 .

			VWS	1	
		15		2	
			(RF)	2	
				1 3	
			(RF)	1 3 RF 3	
		10		2	
				6 2	2
		10	VWS		2 3
				3	
30		5			2
			(VWS)	1	2
		15	(DPS)	2 8	
					2 3
				2	
		10			4
			4	2	

11.

4-11

			()		
1			60	2	
2			3	2	
		---	---		

			()		
1			60	3	
2			298	8	
		---	---		

			()		
1			298	4	
2			3	3	
		---	---		

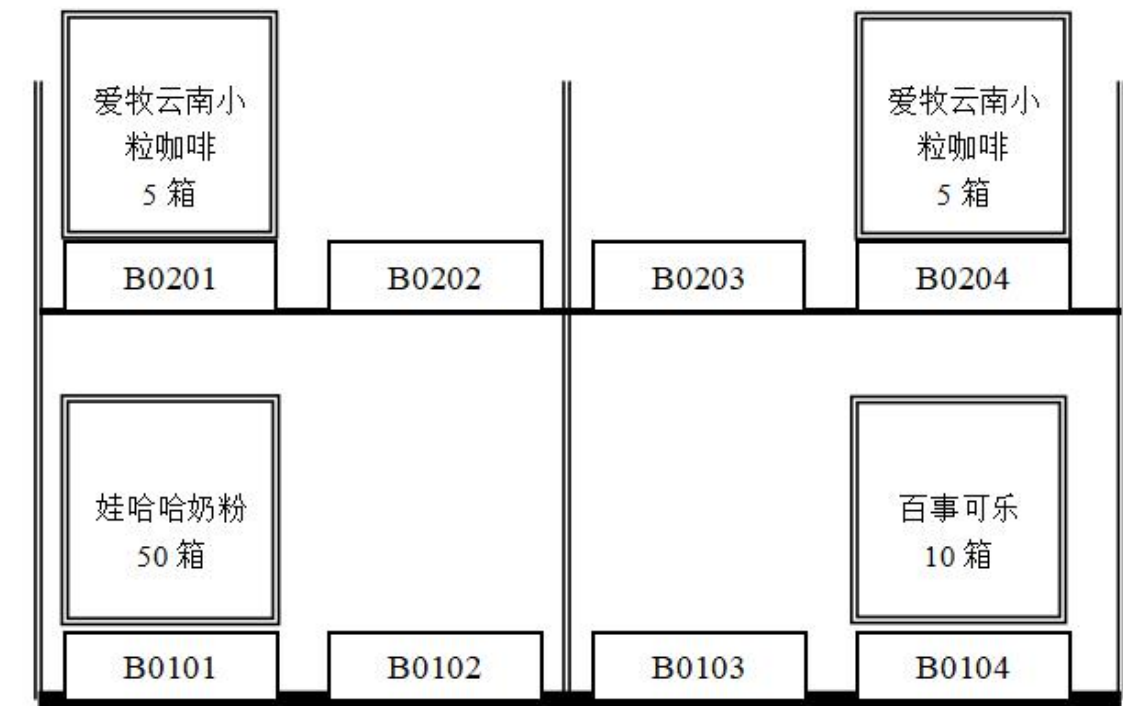
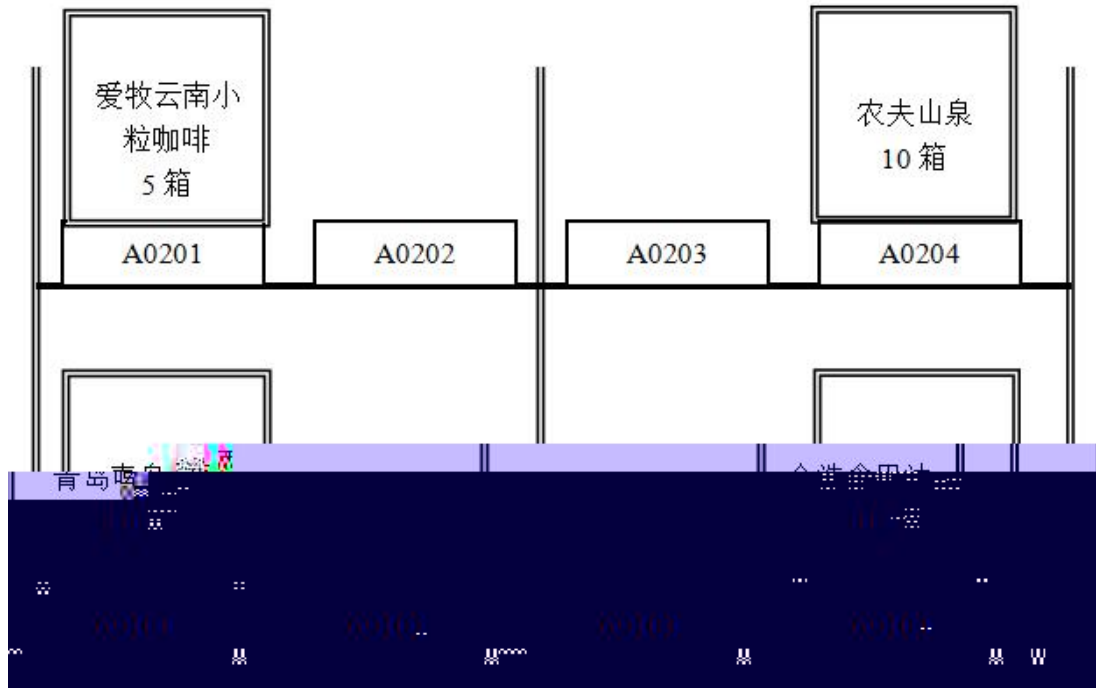

a. W\$

b

- c.
- d.
- e.
- f.
- g.
- h.

RF

			()		
1			4.5	1	
2			2	2	
3			3	4	
4			3	2	

- a.
- b.
- c.
- d.

2

--	--	--

	1	
	2 2 2x 2 1 1	
	2 1 1 1 RF 2 1	
	2 1 1	
	1200x 1000x 144 mm 10 10	
	2 1	

3

60

4

	20		3	2
				5
		7S	7S	10
50	5		1	2
				2
	5	WWS	1	2
			2	1
	5	WWS		4
		WWS	1	
15			2	
	(RF)	2	2	

				1	3
			(RF)	1	3
	10			RF	3
				2	2
	10	VW\$		6	2
				2	
30	5				2
			(VW\$)	1	2
	15		(DPS)	2	8
					2
	10				3
				2	
				4	
			4	2	

12

4-12

1

			()		
1			2	3	
2			298	3	
		---	---		

			()		
1			2	7	
2			298	2	
		---	---		

			()		
1			298	4	
2			5	5	
		---	---		

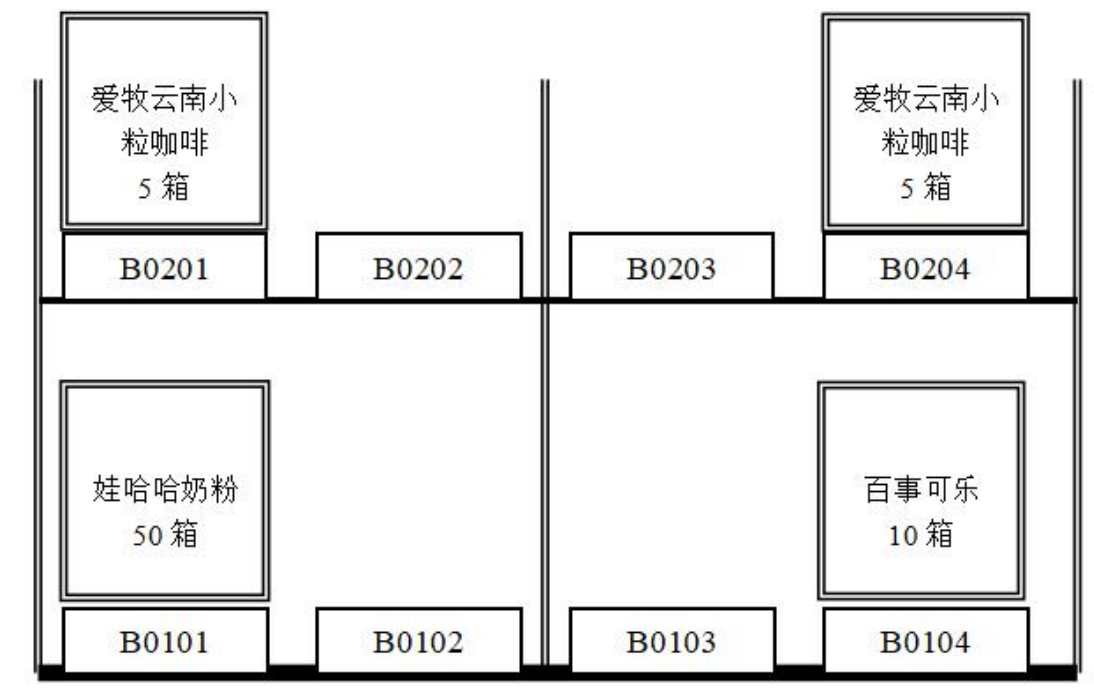
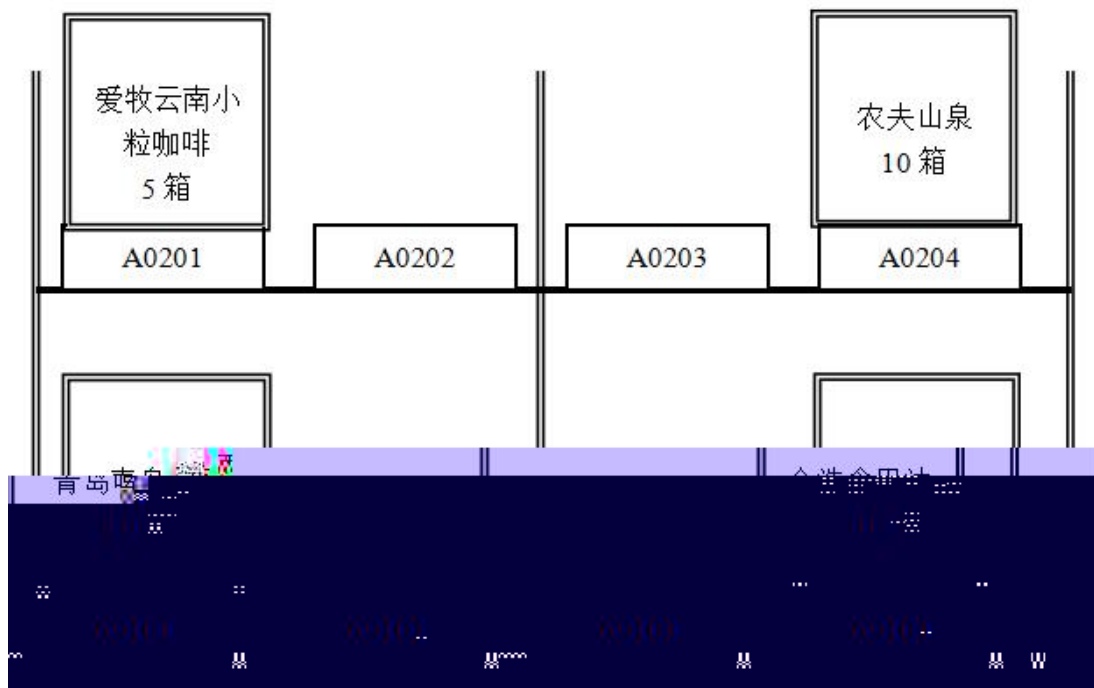

a. W\$

b

c.

d.

e.

RF

f.

g.

h.

			()			
1			4.5	2		1
2			2	2		2
3			3	3		3
4			3	1		4
		---	---			

a.

b

c.

d.

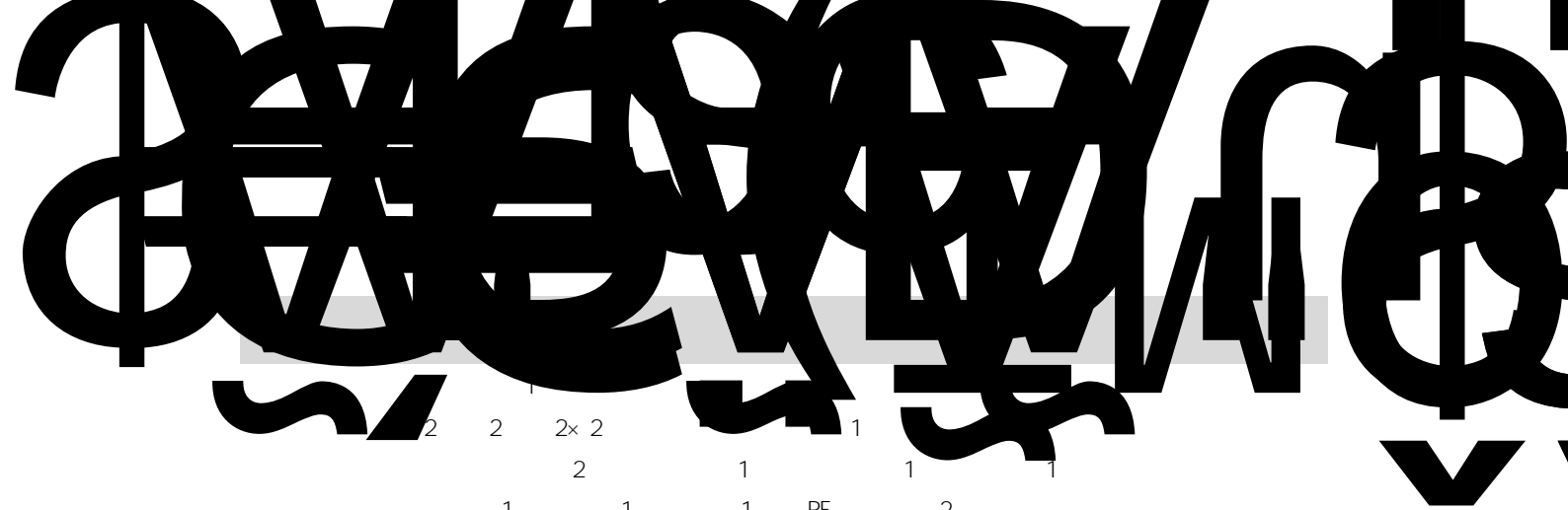

2 2 2x 2 1 1 1 1 1 1 1
2 1 1 RF 2
2 1 1
1200x 1000x 144 mm 10 10
2 è

6

09 : "

%

			()		
1			5	3	
2			298	4	
3			3	2	
		---	---		

			()		
1			5	2	
2			298	3	
3			3	1	
		---	---		

			()		
1			5	1	
2			298	2	
3			3	3	
		---	---		

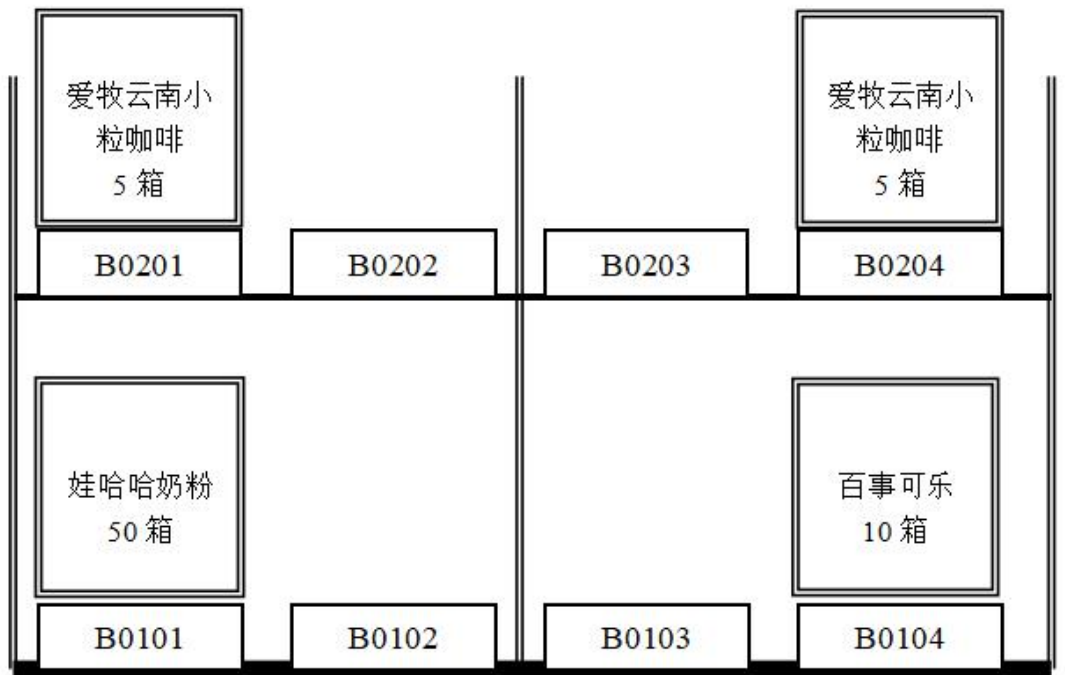
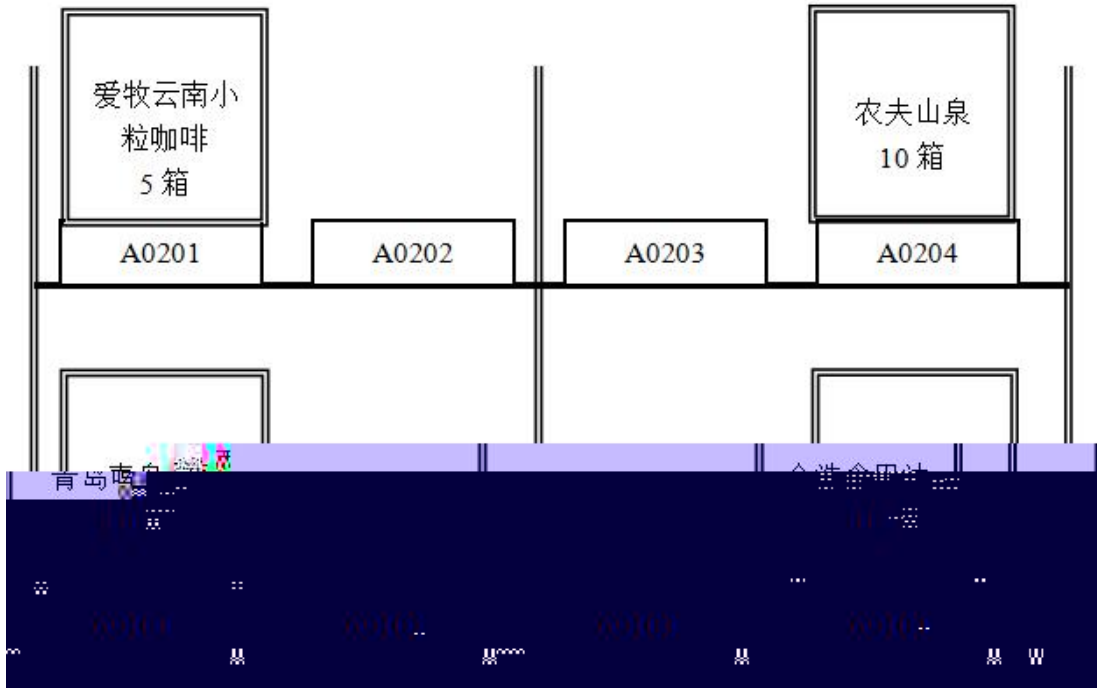

a. WWS

- b
- c.
- d.
- e.
- f.
- g.
- h.

RF

			()		
1			4.5	4	1
2			2	3	2
3			3	1	3
4			3	2	4

- a.
- b
- c.
- d.

	1	
	2 2 2x 2 1 1 2 1 1 1 RF 1 1 2 1 1	
	1200x 1000x 144 mm 10 10	
	2 1	

3

60

4

			3	
	20		2	
			5	
		7S	7S 10	
	5		1	
			2	
			2	
	5	VWS	1 2	0
			2	
			1	
	5	VWS	4	
50			1	
		VWS		
	15		2	

(RF) 2
2 1 3

(RF) 1 3
RF 3

10 2 2
6 2

W\$ 2 3
3

10 2 2
5

1

			()		
1			5	3	
2			298	1	
		---	---		

			()		
1			5	2	
2			298	2	
3			2	6	
		---	---		

			()		
1			5	2	
2			298	4	
3			2	4	
		---	---		

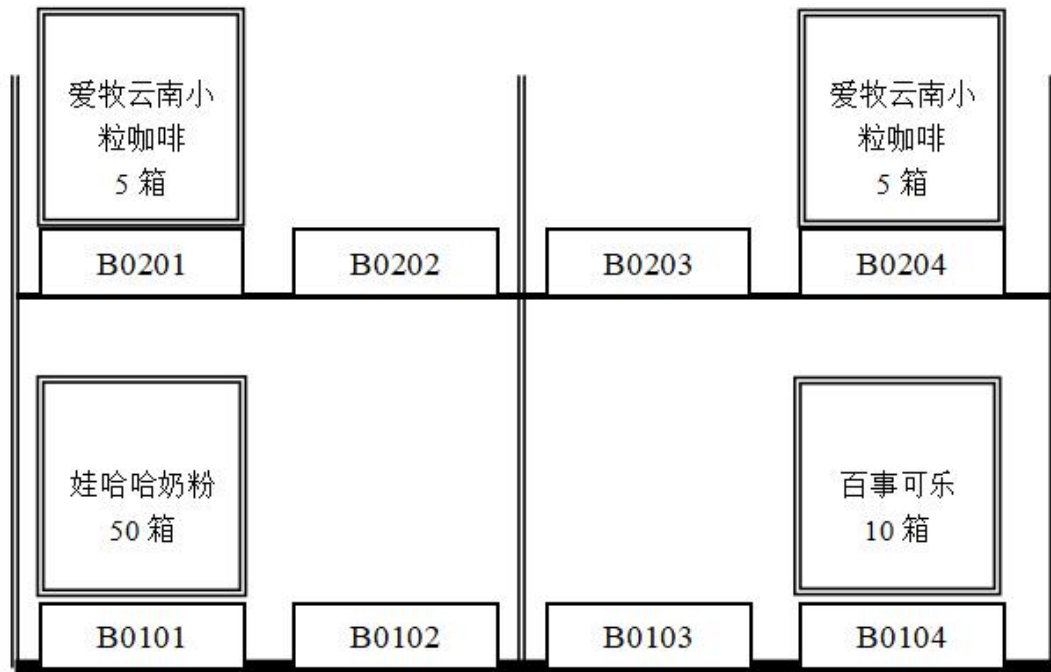
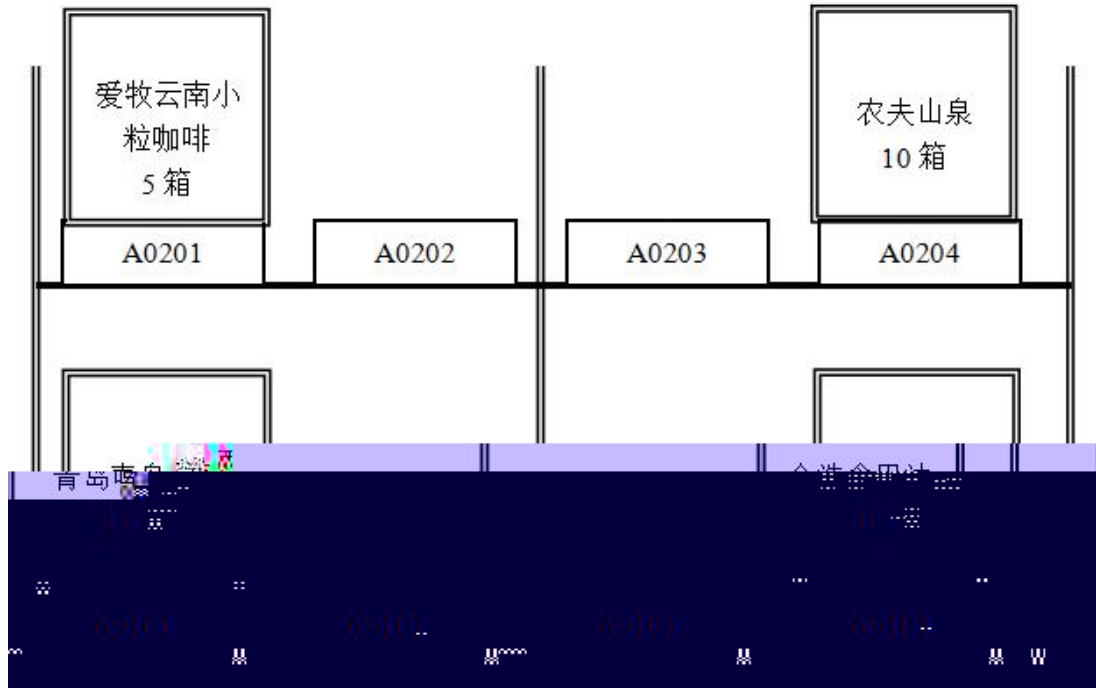

- a. WWS
- b.
- c.
- d.
- e. RF
- f.
- g.
- h.

			()		
1			4.5	2	
2			2	1	
3			3	3	
4			3	1	

- a.
- b.
- c.
- d.

	1	
	2 2 2× 2 1 1	
	2 1 1 1 RF 1 1	
	2 1 1	
	1200× 1000× 144 mm 10 10	
	2 1	

3

60

4

	20		3 2	
			5	
		7S	7S 10	
	5		1 2 2	
	5	VW\$	1 2	
			2 1	
50	5			4
				0

			VWS	1		
		15		2		
			(RF)	2		
				1 3		
			(RF)	1 3 RF		
		10		2		
				6 2		
		10	VWS		2 3	
				3		2
30		5			2	
			(VWS)	1		2
		15	(DPS)	2 8		
					2 3	
				2		
		10				4
				4		2

15.

4-15

			()		
1			60	1	
2			5	5	
		---	---		

			()		
1			60	2	
2			5	5	
		---	---		

			()		
1			60	2	
2			3	4	
		---	---		

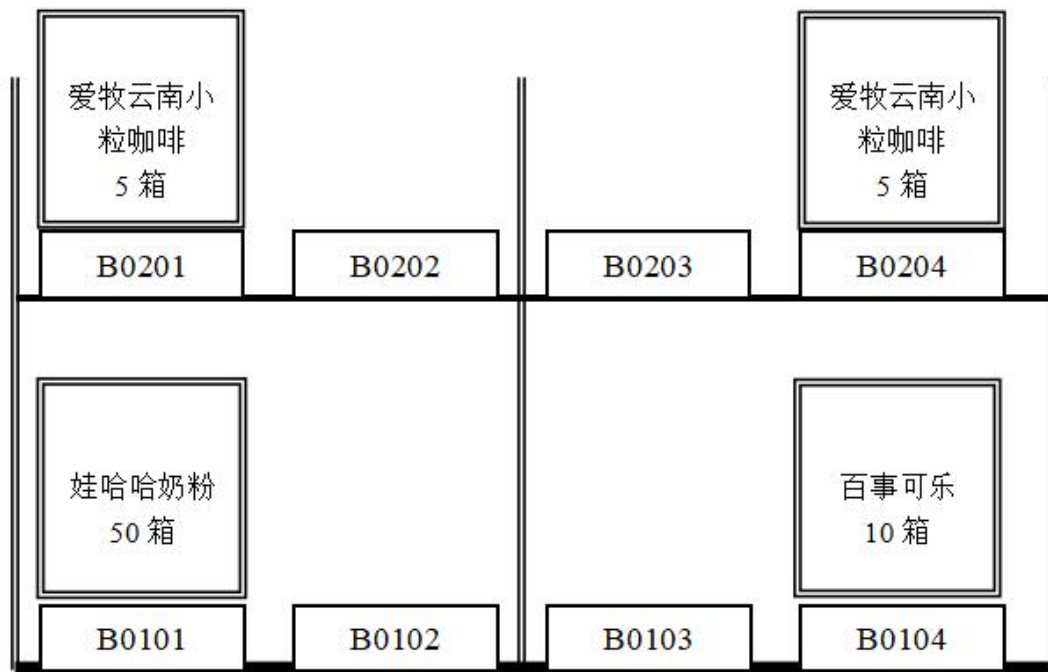
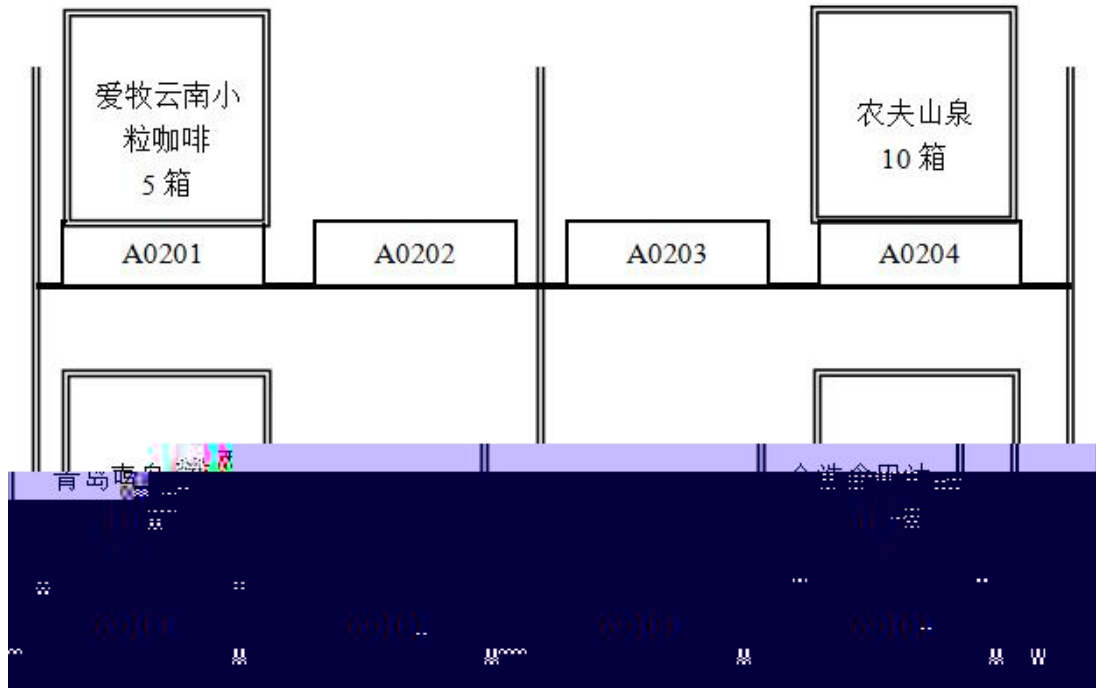

- a. VW\$
- b.
- c.
- d.
- e. RF
- f.
- g.
- h.

			()		
1			2	3	
2			3	8	
3			3	3	
		---	---		

- a.
- b.
- c.
- d.

2

--	--	--

	1	
	2 2 2x 2 1 1	
	2 1 1 1 RF 2 1	
	2 1 1	
	1200x 1000x 144 mm 10 10	
	2 1	

3

60

4

	20		3 2 5 7S 10	
50	5		1 2 2	0
		VWS	1 2 2 1	
	5	VWS	4	
		VWS	1	
	15		2	

30

	(RF)	2	2
		2	1 3
	(RF)		1 3
			RF 3
			2
10		6	2
		2	
	W\$		2
10			3
		3	
			2
			2
5			1
	(W\$)		2
	(DPS)		
15		2	8
			2
			3
		2	
			4
10			
		4	
			2

1

1

- a.
- b.
- c.
- d.

TACT RATES BOOKS

" 1893"

320

102 cmx 44 cmx 25cmx 5

6000

1

SHANGHAI Y. RENMINGBI		CN CNY	SHJ KGS
OSAKA	JP	M	230. 00
		N	37. 51
	0008	45	28. 13
		300	18. 80
		500	20. 61
		300	18. 43

2

2

	2	30

	1	30	40	
	Office	5		
		30		
	30	2		

3

90

4

(20)	5		5	0
	5		1	
	10		4	
(80)			5	
	15		5	
			15	
	10		10	
		ISO		
	10		2	8
	20		10	10
			10	

		25		10	
					10
					5

2

5-2

1

1

:
 :
 : XX XX XX
 : Cl F
 :
 : 35
 : 40
 : 40

1		
2	4	5
		6
		/
3		

7

8

40m3

35T

USD1 000/TEU USD1 800/FEU

ISO

1m× 1m× 1m
1AA 1CC

XFT

2002/C NO 245789

NEW YORK

NO 1—40

35

40

40

300 /

WM

2

2

	2	30
	1	30 40
	Office 5	
	30	
	30	2

--	--	--

3

90

4

5

5

1

(20)

5

4

5

0

10

5

20

5

15

20

20

(80)

ISO

15

3.

5-3

1

1

"

"

a.

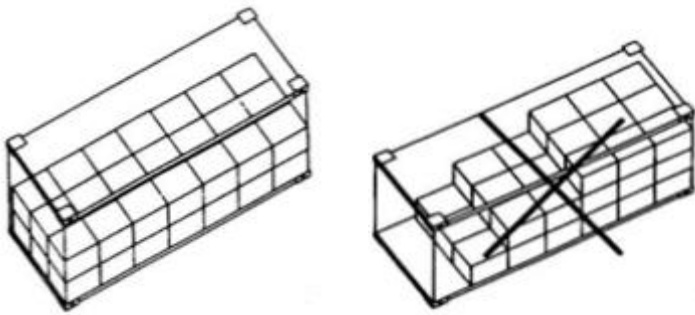

b.

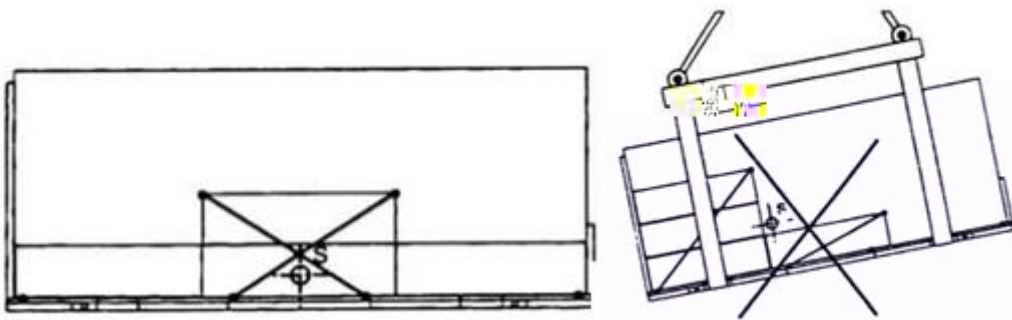

c.

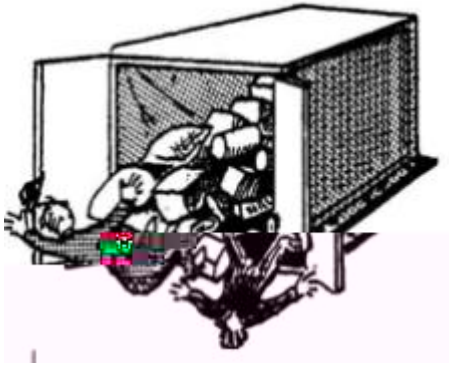

d.

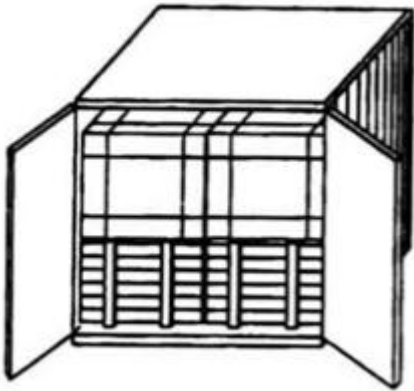

SMCO

2002/C NO. 245789

NEW YORK

NO. 1—20

20ft

19.5m³

15t

USD18.5M

21.5t

2

2

2

30

--	--	--

3

90

4

(20)		5		5
		5		1
		10		4 5
				5
(80)		15		5 10
		10		10
		10	ISO	2 8
		15		10 5

	15		15
	15		5 8 2

4.

5-4

1

1

A

B

船公司 Carrier	船名/航次 Voyage	服务代码 Service	航线 Lane	装船港/卸船港 Load/Unload Port	启-达日期 ETD-ETA	天 Day	挂港
MSC 地中海航运	MASTER HQ409M		中国-香港	HONG KONG 香港 KAOHSIUNG 高雄	02/25(二) 03/15(六)	15	
NYK 日本邮船	ITALIAN EXPRES S/024		中国-东南亚	HONG KONG 香港 BANGKOK 曼谷	02/25(二) 03/02(日)	5	
CMA-CGM 达飞轮船	CMA CGM GEMINI TIA49E		中国-非洲	XIAMEN 厦门 DURBAN 德班	02/25(二) 03/27(四)	30	
KLINE 川崎汽船	HYUNDAI PLATINUM M/004W		中国-中南美	SHANGHAI 上海 PAMANAGUA 巴拉那瓜	02/25(二) 04/09(三)	43	
DMS 达茂轮船	COSCO KAOHSIUNG G/GFS46E		中国-澳新	HONG KONG 香港 NOUMEA 努美阿	02/25(二) 04/02(三)	36	
RCL 达海轮运	KOTA PERMASAN VFM114		中国-中东/ 波斯湾/印巴	QINGDAO 青岛 MADRAS 马德拉斯	02/28(五) 03/18(二)	18	
ZIM 以星轮船	KUO HUNG 311	CHINA_VIETNAM AM(CVX)	中国-港澳台	NINGBO 宁波 HONG KONG 香港	02/25(二) 03/15(六)	18	
SAFMARINE 比利时商船	HEIKE P 1404		中国-非洲	KAOHSIUNG 高雄 MINDELO	02/25(二) 04/05(六)	39	
CSAV 南美邮船	CAP SAN NICOLA S/01409		中国-中南美	SHANGHAI 上海 RIO GRANDE 里奥格兰德	02/25(二) 04/07(一)	41	
OOCL 东方海外	DRESDEN EXPRES S/16808	Pacific Atlantic (PAX)	中国-美东	SHANGHAI 上海 HALIFAX 哈利法克斯	02/25(二) 04/14(一)	48	

a. ETD ETA

b.

c.



DURBAN 20 CAPE TOWN
 USD80.0/FT
 " WM

17.8 A

USD3.0

a. B A ?
 b. USD1100.0/TEU
 10 10 ()?

c. ?
 2
 2

2 30
 1 30 40
 Office 5
 30
 30 2

(20)		5		1	0
		10		4 5 5	
(80)		10		10	
		15		5 10	
		10		10	
		15		10 5	
		15		15	
		15		5 8 2	

1

1

a.

b.

c. " Nature and quantity of Goods" ,

d.

e.

Routing BEIJING CHINA BJS to BOSTON U.S.A BOS

Commodity Gold Watch

Gross Weight 32.0Kgs

Dimensions 1Piece 61X51X42CM

BEIJING	CN		BJS
Y. RENMINBI	CNY		KGS
BOSTON	15000000	15000000	2000000
		15000000	2000000
		15000000	2000000
		15000000	2000000
		15000000	2000000
		15000000	2000000
		15000000	2000000

Normal GCR 200%

2

2

2

30
p f

	20		20	
	25		10	10
			5	

6. 5-6

1

1)

Beijing textiles Imp. And Exp. Corp, M&I s Co., 126 Rome
street, Antwerp, Belgium Boy' s sport sui t, 3600 , 20
CFR , , 10 , 50cm* 20cm* 30cm 10
/ , () : M&I S/ANTWERP/NOS: 1-30 2013 5 18
E0002 " MARRY"

:

"

"

"

"

BI LL OF LADI NG

Shi pper (1)

Consi gnee (2)

Noti fy Party (3)

Ocean Vessel (4)

Voy. S/O No. 898 B/L No. 567

Port of Loadi ng (5)

Port of Di scharge (6)

Frei ght payabl e at (7)

Parti cul ars furni shed by the Shi pper

Marks and Numbers	No. of Packages	Description of goods	Gross Weight	Measurement
-------------------	-----------------	----------------------	--------------	-------------

	(8)	(9)	(10)	
--	-----	-----	------	--

Total Packages (In words)

Freight and Charges

Date

at

(1)

(2)

(3)

:

Beijing textiles Imp. And Exp. Corp, Melis Co., 126 Rome
street, Antwerp, Belgium Boy's sport suit, 3600, 20
CFR , 10 , 50cm*20cm*30cm 10
/ , () : MLS/ANTWERP/NOS: 1-30 2013 5 18
E0002 " MARRY" B123456

2

2

	2	30
		1 30 40
	Office	5
		30
	30	2

3

90

4

(20)	5		5	0
	5		1	
	10		4 5 5	
(80)	20		20	
	10		5 5	
	15		9 6	
	15		15	
	20		10 10	

7.

5-7

1

1)

" full sets of original clean on board ocean bill of lading made out to order of Royal Bank Canada and marked Freight Prepaid notify applicant"

- a. 5
- b. 5
- c. 5

CIF

- a.
- b.
- c.

2013 8

CIF

2

2

	2 30	
	1 30 40	
	Office 5	
	30	
	30 2	

3

90

4

(20)	5		5	0
	5		1	
	10		4 5 5	
(80)	20		20	
	10		5 5	
	15		9 6	
	15		7 8	
	20		10 10	

8.

5-8

1

1)

Shipper ABC Co Ltd

consignee To Order

Notified Party XYZ Co Ltd

a.

b.

c.

d. XYZ Co Ltd

CI F

a.

b.

c.

ABC

XYZ

100

30

:

2012

ABC

XYZ

10

6

D/P

26

2013 3

4

a.

b.
2

2

	2	30
		1 30 40
	Office	5
		30
	30	2

3

90

4

(20)	5		5	0
	5		1	
	10		4 5 5	
(80)	20		20	
	10		5 5	
	15			

			9	6
	15		7	8
	20		10	10

9. 5-9

1

1)

Applicant Nissho Iwai Corporation No. 4-5 Akaasaka 2-Chome Minato-ku Tokyo Japan

Beneficiary China National Mine Import and Export Corp Beijing P. R. China

Pre-advise Bank of China Beijing Branch Full sets of clean on board marine bill of lading made out to order of shipper and blank endorsed and marked freight prepaid and notify applicant

(1) ?

(2) ?

(3) ?

CI F

(1)

(2)

(3)

2

2

	2	30
	1	30 40
	Office	5
		30
	30	2

3

90

4

(20)	5		5
	5		1
	10		4 5 0
(80)		20	5 20

	10		5	5
	15		9	6
	15		8	7
	20		10	10

10. 5-10

1

1)

:

Routing: SHANGHAI CHINA SHA to PARIS FRANCE PAR

Commodity TOY

Gross weight 5.6kgs

Dimensions 40cmx 28cmx 22cm

SHANGHAI	CN	SHA
Y. RENMINBI	CNY	Kgs

PARI S	FR	M	320.00
		N	50.22
		45	41.43
		300	37.90
		500	33.42
		1000	30.71

No. of Pieces Rcp	Gross Weight	K g L b	Rate Class	Chargeable Weight	Rate / Charge	Total	Nature and Quantity of Goods (Incl. Dimension or Volume)
			Commodity Item No.				

2

2

	2	30
	1	30 40
	Office 5	
	30	

	30	2	
--	----	---	--

3

90

4

(20)	5		5	0
	5		1	
	10		4 5 5	
(80)	20		20	
	10		5 5	
	15		9 6	
	15		8 7	
	20		10 10	

11. 5-11

1

2 20 JS " "

MM Al en

2 21 18: 00

100

2 21 18: 30

Al en

10

1)

?

: :"

18: 00 "

2009. 02. 21 02: 00

2 20

l i x i a n s h e n g @ 1 2 6 . c o m

2

	2	30
		1 30 40
	Office	4
		30
	30	2

3

90

4

(20)	5		5	0
	5		1 4	
	10		5 5	
(80)	15		8 7	
	15		8 7	

	15		5 5 5	
	20		5 5 5 5	
	15		5 10	

12

5-12

1

A B

FOB

D

D

A

B

A

A

B

B

l i x i a n s h e n g @ 1 2 6 . c o m

2

2

	2	30
		1 30 40
	Office	4
		30
	30	2

3

90

4

(20)	5		5	0
	5		1	
	10		4 5 5	
(80)	15		8 7	
	15		8 7	

	15		5 5 5	
	20		5 5 5 5	
	15		5 10	

13.

5-13

1

20 80

140

" "

2

2

	2	30
		1 30 40
	Offi ce	4
		30
	30	2

3

90

4

(20)	5		5	0
	5		1	
	10		4	
			5	

(80)	15		7 8
	15		8 7
	15		5 5 5
	20		5 5 5 5
	15		5 10

14.

5-14

1

UPS

1907

UPS

34

2400

16

610

UPS

:

1.

UPS

3

;

8

1h

20

90

UPS

180

24h

"

"

UPS

"

"

"

"

2.

UPS

"

" UPS

3.

UPS

"

"

"

"

4.

UPS

"

"

"

"

"

"

UPS

4.

UPS

"

"

"

"

UPS

UPS

UPS

2

2

	2	30

	1	30	40	
	Office	4		
		30		
	30	2		

3

90

4

5

5

1

5

(20)

4

5

0

10

5

15

8

7

(80
)

	20		5 5 5	
	15		5 10	

15.

5-15

1

1990

2004

www.ejctrans.com

4000204446

2004

200

2007

"

"

6000

1990

3

200

300

4000204446

— www.ejctrans.com

"

24

"

1)

18

2

2

2

	2	30
	1	30 40
	Office	4
		30
	30	2

3

90

4

(20)	5		5	0
	5		1	
	10		4	
			5	

(80
)

	15		8 7	
	15		8 7	
	15		5 5 5	
	20		5 5 5 5	
	15		5 10	

003

1.

6-1

1

1

2013 11 29

2013 12 20

11 29

3

2013 11 30

MP4

	1	
	10	8

2

2

	1	30
		1 30 40
	Offi ce	5
		30
	30	2

3

90

4

(20)	10		5	0
			5	
(80)	10		5 5	
	12		8 4	
	10		7 3	

	12		9	3
	6		6	
	10		8	2
	10		8	2
	20		5	

2

6-2

1

1

2012 9

6 300

"

"

5 250

5

500

500

15000

50cm

40cm

60cm

5kg

8



	1	
	10	8

快运详情单
EXPRESS WAYBILL

0 2 0 0 0 0 5 6 1 7 6 0 3

寄件人: 陈市伟 Send By: 陈市伟	始发地: 天河区 Origin: 天河区	收件人: 陈牛伟 Received By: 陈牛伟	目的地: 开福区 Destination: 开福区
寄件地址: 广东省广州市天河区 From: 广东省广州市天河区	收件地址: 海南省长沙市开福区 To: 海南省长沙市开福区	浏阳河大桥东	
单位: ×××医院保健科 Company: ×××医院保健科	单位: 湖南卫视电视台国际频道总监室 Company: 湖南卫视电视台国际频道总监室		
电话: 020-868****4 Tel: 020-868****4	手机: 1386****3886 Mobile: 1386****3886	电话: 0731-82***6808 Tel: 0731-82***6808	手机: Mobile:
请您在签字前阅读背书条款, 贵重物品请保价未保价物品的理赔为资费的5倍。			件数:
发件人 签名	揽件人 签名	收件人 签名	重量:
月 日 时	月 日 时	月 日 时	资费:
内件说明: <input type="checkbox"/> 货样 <input type="checkbox"/> 非货样	付款方式: <input type="checkbox"/> 现付 <input type="checkbox"/> 月结	<input type="checkbox"/> 本人签收 <input type="checkbox"/> 同事签收 <input type="checkbox"/> 家属签收 <input type="checkbox"/> 其他人签收	总资费:
0200005617603		备注:	

2

2

	1	30
	1	30 40
Of fi ce	5	
	30	
30	2	

3

90

4

(20)	10		5	0
	10		5 5	
80	12		9 3	
	12		3	
	9		3	
	9		3	
	10		8 2	
	8		6 2	
	20		4	

3.

6-3

1

1

2014 9

500

10

8

2

15 /

10

14 /

2014 9 12

3

2014

2

2

	1	30
		1 30 40
	Office	5
		30
	30	2

3

90

4

(20)	10		5
			5

		10		5	
			7S	5	0
		10		8	1
		5		5	1
		5		1	
				1	
				10	4
					2.5
(80				16	
)				4	
		40		4	4
					4
					8
				1	8
					5
				6	
				1.2	
		20			20
					1

4. 6-4

1

1

2010 8 10

60

5

300

10

5 B A 60 40 6000 2
60 40 30 30 18

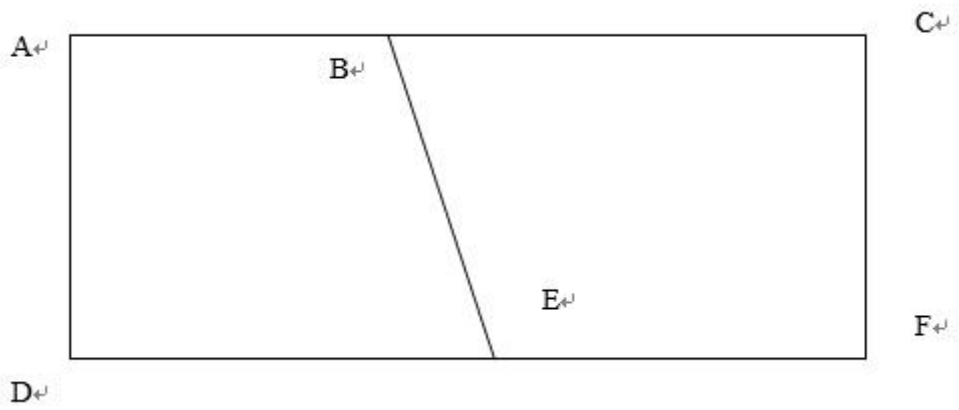

A B 1 C

E F

D

A B 40 B C 40 C F 30

F E 40 E B 30 E D 40 A D

20

2

2

	1 30	
	1 30 40	
	Offi ce 5	
	30	
	30 2	

3

90

4

(20)	10		5	0
	10		5 5	
80	10		2	
	10		5	

	10		1	10
	10		7	3
	10			
	9		3	
	6		2	4
	15			5

5.

6-5

1

1

125

3500

2 250

?

YTO EXPRESS 圆通速递
 服务热线: 021-6977888 网址: www.yto.net.cn

客户要办 务速便办
 目的地名称 (Destination)

发件人信息 (Shipper's Information)
 发件人 (Shipper) **1** 出发地 (Departure) **2**

收件人信息 (Receiver's Information)
 收件人 (Receiver) **9** 目的地 (Destination)

详细地址 (Detail Address)
 省 (Province) **3** 市(县) (City) 区(镇) (Town) **10**

单位名称 (Company Name) **4**

电话 (Tel) **5** 手机 (Mobile) **11**

内件说明 (Description) **6** 文件 (Sample) 物品 (Goods)

发件人签名 (Shipper's Signature) **7** 年月日 (Y M D) **8**

收件人签名 (Receiver's Signature) **12** 年月日 (Y M D) **13**

0123456789 通过ISO9001:2000质量管理体系认证 请用力正横填写PRESS HARD

1-13

2

2

	1	30
		1 30 40
Office	5	
	30	
30	2	

3

90

4

--	--	--	--

(20)	10		5	
	10		5 5	0
(80)	9		3	
	14		10 4	
	12		4	
	10		7 3	
	10		5	
	12		3	
	13			1

6.

6-6

1

1

?

?

2

2

	1	30
		1 30 40
	Office	5
		30
	30	2

3

90

4

(20)	10		5	0
	10		5 5	
80	10		5	
	8			

			2	
	12		4	
	25		9	8
	9		5	4
	16		4	

7. 6-7

1

1

" "

25

7-10

" " "

7 19

"

"

60 cm 40 cm 30 cm 24. 1kg

	1kg	1kg<	20kg	20kg<	50kg
—	12	6 /kg		5 /kg	

—	10	2 /kg	1 /kg
---	----	-------	-------

60cm 40cm 30cm

14

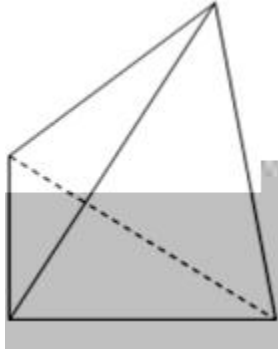

—	20 /	8 /
—	30 /	12 /

2

2

	1	30
		1 30 40
	Office	5
		30
	30	2

3

90

4

(20)	10		5	0
			5	
80	10		5	
			5	5
	10		5	5
			5	5
	10		2	8
			2	10
	15		5	

8.

6-8

1

1

A

3

A

A

A

?
4CM



4

?

4

2

2

	1 30	
	1 30 40	
	Office 5	
	30	
	30 2	

3

90

4

(20)	10		5	0
	10		5 5	
80	8		2	
	10		5	
	10		5	
	12		3	
	10		10	
	20		4	
	10		2.5	

9

6-9

1

1)

2014 3 2 10

3 3

17

3 4

3 4 18

2

2

	1 30	
	1 30 40	
	Office 5	
	30	
	30 2	

3

90

4

(20)	10		5

				5	
		10			0
				5	
				5	
(80)		10		5	
					8
		15		7	
		20		4	
		15		7	8
		20		4	

10.

6-10

1

1

			0351-69454 19	030025	
		23	139788188	530012	
		139	0871-31733 16	650011	



4

A

B

C

D

2

2

1

30

1

30 40

Offi

--	--	--

3

90

4

(20)	10		5	0
	10		5	
(80)	9		3	
	12		4	
	10		2	
	16		4	
	18		3	
	15		3	

11.

6-11

1

1

2011 1 2

1 7

"

"

"

"

"

13823417685

"

"

"

5

"

"

"

"

2

"

"

"

"

"

"

"

Q

"

"

"

"

"

"

"

"

"

2

2

	1 30	
	1 30 40	
	Office 5	
	30	
	30 2	

3

90

4

(20)	10		5	
			5	

		10		5 5	0
(80)		30		15 5	10
		15		5	
		20		10	
		15		5	

12

6-12

1

1

2011 1 2

1 7

"

"

"

"

"

13823417685

"

"

"

5

"

"

"

"

"

"

"

"

"

"

"

Q

"

"

"

"

"

"

"

"

"

2

2

	1	30
	1	30 40
	Office	5
		30
	30	2

3

90

4

(20)	10		5	0
			5	
(80)	10		5	5
(80)	6		2	
		12		

			4
	6		2
	20		
	16		4
	20		5

A

11 29

1

11 23

11 24

45KG

0.3

11 25

11 26

12 3

12 6

11 25

11 26

?

2

2

	1 30	
	1 30 40	
	Office 5	

	30	
30	2	

3

90

4

(20)	10		5	0
	10	7S	5	
(80)	20		20	
			1	
	10		1	
	20		6 10	
			2 10	
	30		10 6	
			2	
			20	
			1	

15.

6-15

1

1

2014 9 23 10

735

3

0231234567

11

0241234567

234

10

10

2

2

1

30

1

30 40

Office

5

30

30

2

(20)	10		5	0
	10	7S	5	
(80)	40		20 20	
	10		5 10 1	
	10		1	
	20		10 10	